



Eidgenössische Technische Hochschule Zürich
Swiss Federal Institute of Technology Zurich



Nico Schottelius

High speed NAT64 with P4

DRAFT

Master Thesis MA-2019-19
February 2019 to August 2019

Tutors: Alexander Dietmüller, Edgar Costa Molero, Tobias Bühler
Supervisor: Prof. Dr. Laurent Vanbever

Abstract

Due to the lack of IPv4 addresses, IPv6 deployments have recently gained in importance in the Internet. Several transition mechanism exist that allow translating IPv6 packets into IPv4 packets, thus enabling the coexistence and interoperability of both protocols.

This thesis describes an implementation of the transition mechanism NAT64 implemented in P4. Using the P4 programming language a software emulated switch was created that translates IPv4 to IPv6 and vice versa. Due to the target independence of P4 the same code can be compiled for and deployed to on the FPGA hardware platform "NetFPGA".

Within the NetFPGA the NAT64 implementation achieves a stable throughput of 9.29 Gigabit/s and allows in network translations without a router. Due to the nature of P4, the implementation runs at line speed and thus with different hardware the same code can run potentially at much higher speeds, for instance on 100 Gbit/s switches.

Contents

1	Introduction	9
1.1	IPv4 exhaustion and IPv6 adoption	9
1.2	Motivation	10
2	Background	13
2.1	P4	13
2.2	IPv6, IPv4 and Ethernet	13
2.3	ARP and NDP, ICMP and ICMP6	14
2.4	IPv6 Translation Mechanisms	15
2.4.1	Static NAT64	15
2.4.2	Stateful NAT64	16
2.4.3	Higher layer Protocol Dependent Translation	16
2.4.4	DNS64 - FIXME	16
2.4.5	Prefix based NAT - FIXME	16
2.5	Protocol Checksums	17
2.6	Network Designs	18
2.6.1	IPv4 only network limitations	18
2.6.2	Dualstack network maintenance	19
2.6.3	IPv6 only networks	19
3	Design	21
3.1	General - FIXME	21
3.2	BMV2	22
3.3	NetFPGA	22
3.4	Benchmarks	23
4	Results	25
4.1	NAT64 with P4	25
4.2	BMV2	25
4.3	Tayga	25
4.4	Jool	26
4.5	NetFPGA	26
4.5.1	Checksum computation	26
4.5.2	to be named	26
4.6	NAT64 in Software	26
4.7	Feature comparison	27
4.8	todo - FIXME: remove	27
5	Conclusion	29
5.1	Software based NAT64	29
5.2	General	29
5.3	BMV2	29
5.4	P4	29
5.5	NetFGPA - all HERE	30
5.6	Real world applications	33
5.7	Outlook	33
5.8	Closing words (NAME?)	33

5.9	todo - FIXME: remove	33
A	Resources and code repositories	35
A.1	Master Thesis	35
A.2	Xilinx Toolchain	35
A.3	NetFPGA support scripts	35
B	BMV2 environment and tests	37
C	NetFPGA environment and tests	39
C.1	NetFPGA Setup	39
C.2	NetFPGA Compile Flow	39
C.3	NetFPGA NAT64 Test cases	39
C.3.1	Test 1: IPv4 egress	39
C.3.2	Test 2: IPv6 egress	40
C.3.3	Test 3: NAT64	41
D	NetFPGA Logs	43
D.1	NetFPGA Flash Errors	43
D.2	NetFPGA Flash Success	43
D.3	NetFPGA Kernel module	44
D.4	NetFPGA misses packets on nf*	45
E	Benchmark Logs	47
E.1	iperf	47
E.2	General	47
E.3	NetFPGA	48
E.4	Tayga	49
E.4.1	Tayga/TCP	50
E.5	Jool	51
E.5.1	Jool Setup	51
E.5.2	Jool Configuration	52
E.5.3	Jool Benchmarks	52
E.5.4	NetPFPGA Benchmarks	54
F	Buffer	55
F.1	NetFPGA compile errors	55
F.2	P4 error messages	61
F.3	Traces	62
F.4	Introduction	62
F.4.1	The Task	62

List of Figures

1.1	LACNIC Exhaustion projection, [22]	9
1.2	Google IPv6 Statistics, [18]	10
1.3	In Network NAT64 translation	10
1.4	Standard NAT64 translation	11
1.5	Different network design with in network NAT64 translation	11
2.1	P4 protocol independence, [45]	13
2.2	IPv6 Header, [15]	14
2.3	IPv4 Header, [36]	14
2.4	ARP and NDP	14
2.5	ICMP6 option fields	15
2.6	Stateful NAT64	16
2.7	IPv6 Pseudo Header	17
2.8	IPv4 Pseudo Header	17
2.9	IPv4 only network	18
2.10	Dualstack network	18
2.11	IPv6 only network	19
3.1	General Design	21
3.2	IPv4 Pseudo Header	22
3.3	Calculating checksum based on header differences	23
3.4	NAT64 in software benchmark	23
3.5	NAT64 with NetFPGA benchmark	24

DRAFT

List of Tables

4.1 Table 1	25
-----------------------	----

DRAFT

DRAFT

Chapter 1

Introduction

In this chapter we give an introduction about the topic of the master thesis, the motivation and problems that we address.

1.1 IPv4 exhaustion and IPv6 adoption

The Internet has almost completely run out of public IPv4 space. The 5 Regional Internet Registries (RIRs) report IPv4 exhaustion world wide ([39], [4], [22], [1], [5]) and LACNIC project complete exhaustion for 2020 (see figure 1.1).

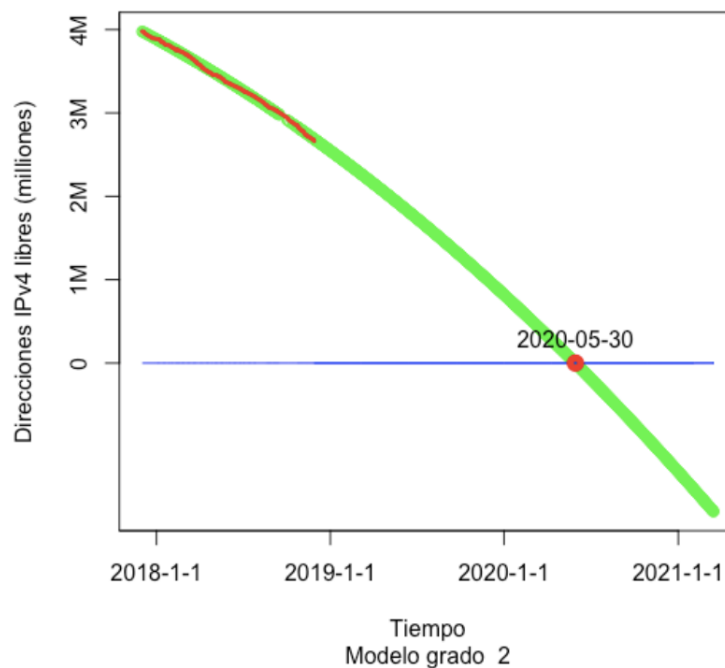

Figure 1.1: LACNIC Exhaustion projection, [22]

On the other hand IPv6 adoption grows significantly, with at least three countries (India, US, Belgium) surpassing 50% adoption ([2], [46]).

[11]). Traffic from Google users reaches almost 30% as of 2019-08-08 ([18], see figure 1.2). We conclude that IPv6 is a technology strongly gaining importance with the IPv4 depletion that is estimated to be world wide happening in the next years. Thus more devices will be using IPv6, while communication to legacy IPv4 devices still needs to be provided.

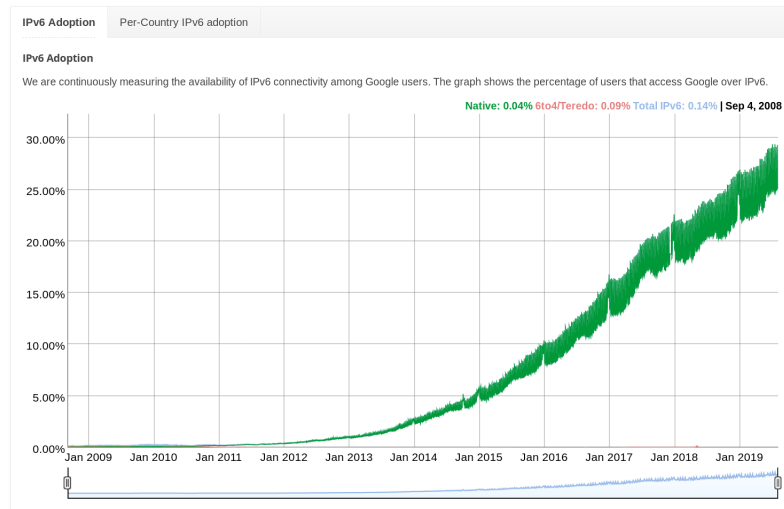

Figure 1.2: Google IPv6 Statistics, [18]

1.2 Motivation

IPv6 nodes and IPv4 nodes cannot directly connect to each other, because the protocols are incompatible to each other. To allow communication between different protocol nodes, several transition mechanisms have been proposed [48], [32].

However, installation and configuration of the transition mechanism usually require in-depth knowledge about both protocols and require additional hardware to be added in the network.

In this thesis, we show an in-network transition method based on NAT64 [6]. Compared to traditional NAT64 methods which require an extra device in the network, our proposed method is transparent to the user. This way, neither the operator nor the end user has to configure extra devices. Figure 1.4 shows the standard NAT64 approach and Figure 1.3 shows our solution. Cur-

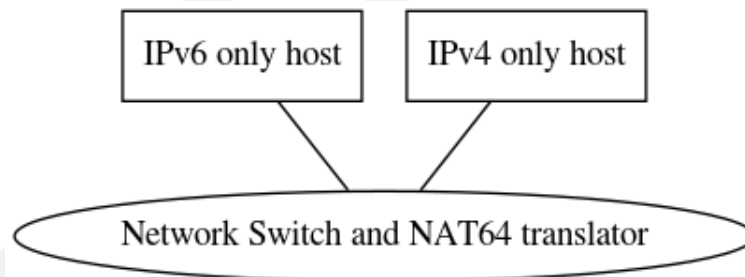

Figure 1.3: In Network NAT64 translation

rently, network operators have to focus on two network stacks when designing networks: IPv6 and IPv4. While in a small-scale setup, this might not introduce significant complexity, Figure 1.5 shows how the complexity quickly grows with the number of hosts. The in-network solution does not only ease the installation and deployment of IPv6, but it also allows line-speed translation, because it is compiled into target-dependent low-level code that can run in ASICs [30], FPGAs [29] or even in software [9]. Even on fast CPUs, software solutions like Tayga [24] can be CPU-bound and are not capable of translating protocols at line speed.

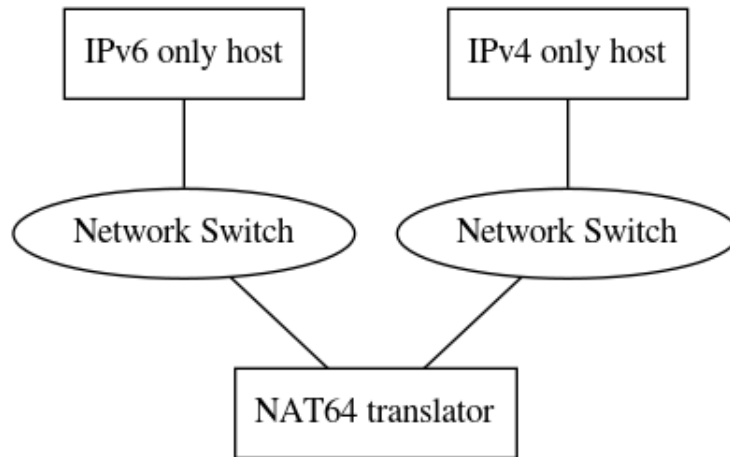

Figure 1.4: Standard NAT64 translation

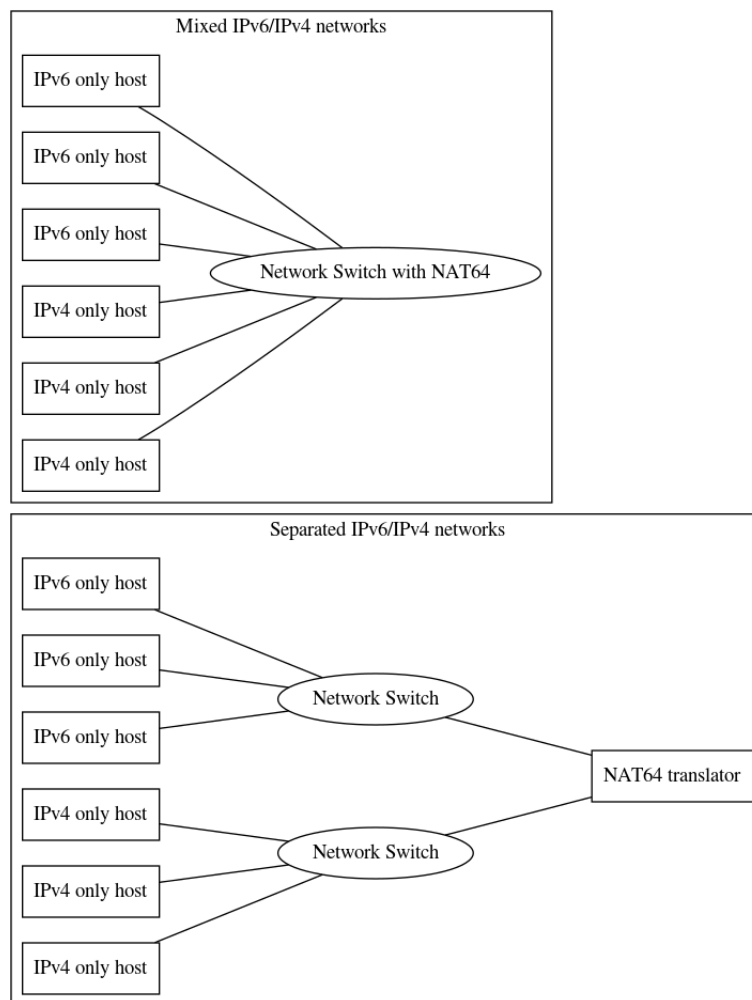

Figure 1.5: Different network design with in network NAT64 translation

DRAFT

Chapter 2

Background

In this chapter we describe the key technologies involved.

2.1 P4

P4 is a programming language designed to program inside network equipment. Its main features are protocol and target independence. The *protocol independence* refers to the separation of concerns in terms of language and protocols: P4 generally speaking operates on bits that are parsed and then accessible in the (self) defined structures, also called headers. The general flow can be seen in figure 2.1: a parser parses the incoming packet and prepares it for processing in the switching logic. Afterwards the packets is output and deparsing of the parsed data might follow. In the context of NAT64 this is a very important feature: while the parser will read and parse in the ingress pipeline one protocol (f.i. IPv6), the deparser will output a different protocol (f.i. IPv4). The *target independence* is the second very powerful feature of P4: it allows

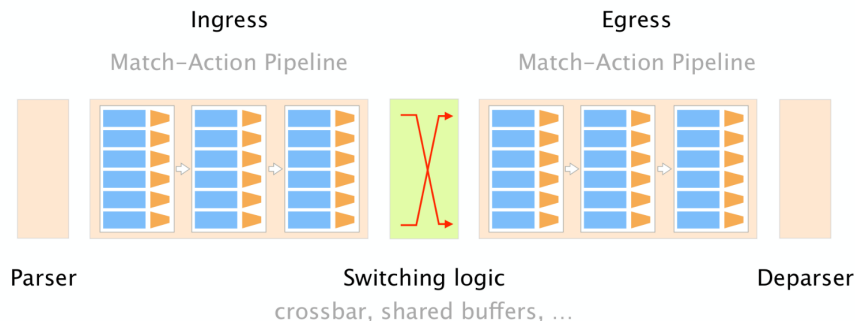

Figure 2.1: P4 protocol independence, [45]

code to be compiled to different targets. While in theory the P4 code should be completely target independent, in reality there are some modifications needed on a per-target basis and each target faces different restrictions. The challenges arising from this are discussed in section 5.4. As opposed to general purpose programming languages, P4 lacks some features, most notably loops. However within its constraints, P4 can guarantee operation at line speed, which general purpose programming languages cannot guarantee and also fail to achieve in reality (see section 4.6 for details).

2.2 IPv6, IPv4 and Ethernet

The first IPv6 RFC was published in 1998[15]. Both IPv4 and IPv6 operate on layer 3 of the OSI model. In this thesis we only consider transmission via Ethernet, which operates at layer 2. Inside the Ethernet frame a field named "type" specifies the higher level protocol identifier (0x0800 for IPv4 [20] and 0x86DD for IPv6 [13]). This is important, because Ethernet can only

carry either of the two protocols. The figures 2.3 and 2.2 show the packet headers of IPv4 and IPv6. The most notable differences between the two protocols for this thesis are:

- Different address lengths (32 vs 128 bit)
- Lack of checksum in IPv6
- Format of Pseudo headers (see section 2.5)

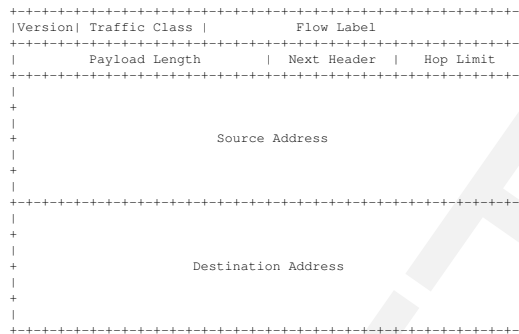

Figure 2.2: IPv6 Header, [15]

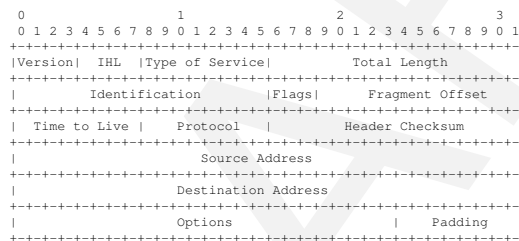

Figure 2.3: IPv4 Header, [36]

2.3 ARP and NDP, ICMP and ICMP6

While IPv6 and IPv4 are primarily used as a “shell” to support addressing for protocols that have no or limited addressing support (like TCP or UDP), protocols like ARP [33] and NDP [28] provide support for resolving IPv6 and IPv4 addresses to hardware (MAC) addresses. While both ARP and NDP are only used prior to establishing a connection on and their results are cached, their availability is crucial for operating a switch. Figure 2.4 illustrates a typical address resolution process. The major difference between ARP and NDP in relation to P4 are

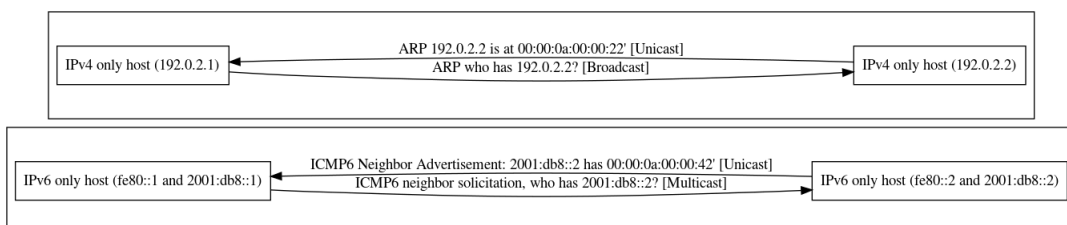

Figure 2.4: ARP and NDP

- ARP is a separate protocol on the same layer as IPv6 and IPv4,

- NDP operates below ICMP6 which operates below IPv6,
- NDP contains checksums over payload,
- and NDP in ICMP6 contains optional, non referenced option fields (specifically: ICMP6 link layer address option).

ARP is required to be a separate protocol, because IPv4 hosts don't know how to communicate with each other yet, because they don't have a way to communicate to the target IPv4 address ("The chicken and the egg problem"). NDP on the other hand already works within IPv6, as every IPv6 host is required to have a self-assigned link local IPv6 address from the range `fe80::/10` (compare RFC4291[19]). NDP also does not require broadcast communication, because hosts automatically join multicast groups that embed parts of their IPv6 addresses ([14], [49]). This way the collision domain is significantly reduced in IPv6, compared to IPv4.

As seen later in this document (compare 4.5.1), the requirement to generate checksums over payload poses difficult problems for some hardware targets. Even more difficult is the use of options within ICMP6. Figure shows a typical layout of a neighbor advertisement messages. The problem arises from the layout of the options, as seen in the following quote:

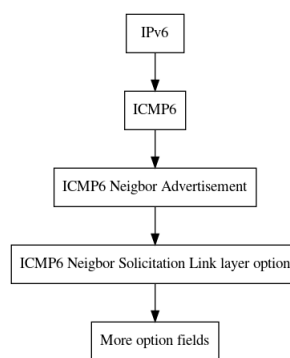

Figure 2.5: ICMP6 option fields

Neighbor Discovery messages include zero or more options, some of which may appear multiple times in the same message. Options should be padded when necessary to ensure that they end on their natural 64-bit boundaries.¹

ICMP6 and ICMP are primarily used to signal errors in communication. Specifically signalling that a packet is too big to pass a certain link and needs fragmentation is a common functionality of both protocols. For a host (or switch) to be able to emit ICMP6 and ICMP messages, the host requires a valid IPv6 / IPv4 address. Without ICMP6 / ICMP support path mtu discovery ([27], [25]) does not work and the sender needs to determine different ways of finding out the maximum MTU on the path.

2.4 IPv6 Translation Mechanisms

While in this thesis the focus was in NAT64 as a translation mechanism, there are a variety of different approaches, some of which we would like to portray here.

2.4.1 Static NAT64

Static NAT64 describes static mappings between IPv6 and IPv4 addresses. This can be based on longest prefix matchings (LPM), ranges, bitmasks or individual entries.

NAT64 translations as described in this thesis modify multiple layers in the translation process:

- Ethernet (changing the type field)
- IPv4 / IPv6 (changing the protocol, changing the fields)
- TCP/UDP/ICMP/ICMP6 checksums

¹From RFC4861.

2.4.2 Stateful NAT64

Stateful NAT64 as defined in RFC6146[6] defines how to create 1:n mappings between IPv6 and IPv4 hosts. The motivation for stateful NAT64 is similar to stateful NAT44[?]: it allows translating many IPv6 addresses to one IPv4 address. While the opposite translation is also technically possible, the differences in address space don't justify its use in general.

Stateful NAT64 in particular uses information in higher level protocols to multiplex connections: Given one IPv4 address and the tcp protocol, outgoing connections from IPv6 hosts can dynamically mapped to the range of possible tcp ports. After a session is closed, the port can be reused again. The selection of mapped ports is usually based on the availability on the IPv4

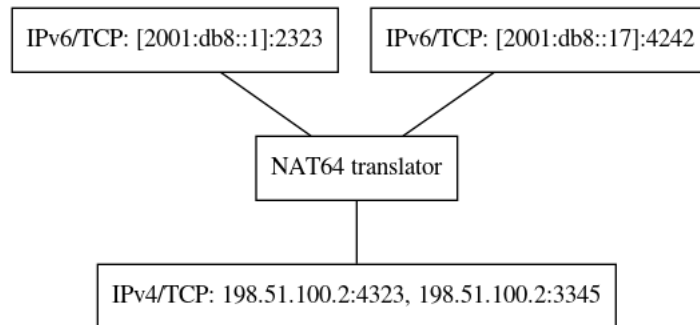

Figure 2.6: Stateful NAT64

side and not related to the original port. To support stateful NAT64, the translator needs to store the mapping in a table and purge entries regularly.

Stateful NAT64 usually uses information found in protocols at layer 4 like TCP [37] or UDP [34]. However it can also support ICMP [35] or ICMP6 [12].

2.4.3 Higher layer Protocol Dependent Translation

Further translation can be achieved by using information in higher level protocols like HTTP [16] or TLS [8]. Application proxies like nginx [31] use layer 7 protocol information to proxy towards backends. Within this proxying method, the underlying IP protocol can be changed from IPv6 to IPv4 and vice versa. However the requested hostname that is usually used for selecting the backend is encrypted in TLS 1.3 [38], which poses a challenge for implementations.

While protocol dependent translation has the highest amount of information to choose from for translation, complex parsers or even cryptographic methods are required for it. That reduces the opportunities of protocol dependent translation

2.4.4 DNS64 - FIXME

DNS64 [21]

2.4.5 Prefix based NAT - FIXME

Explain how it works in general **** RFC6052 - Defining well known prefix 64:ff9b::/96 - Defining embedding depending on prefix: /32../104 in 8 bit steps - Longer than /96: suffix support
- v4 to v6 / vice versa

```

+-----+
|PL| 0-----32-40-48-56-64-72-80-88-96-104-----|
+-----+
|32|  prefix  |v4(32)  | u | suffix  |
+-----+
|40|  prefix  |v4(24)  | u | (8) | suffix  |
+-----+
|48|  prefix  |v4(16)  | u | (16) | suffix  |
+-----+
|56|  prefix  | (8) | u | v4(24) | suffix  |
+-----+
|64|  prefix  | u | v4(32)  | suffix  |
+-----+
|96|  prefix  | v4(32)  |
+-----+

```



```

***** DONE Case IPv6 initiator
CLOSED: [2019-08-13 Tue 10:59]
- Mapping whole IPv4 Internet in /96 prefix
- Session information for mapping reply
- Timeout handling in controller
***** TODO IPv6 udp -> IPv4
- Got 4-5 tuple ([proto], src ip, src port, dst ip, dst port)
- Does not / never signal end
- Needs timeout for cleaning up
***** TODO IPv6 tcp -> IPv4
- Similar to udp
- react on FIN/RST (?) - could be an addition
***** TODO IPv6 icmp6 -> IPv4
- usual protocol specific changes
- Session??
- src ip, dst ip, code ?
***** TODO Case IPv4 initiator
- Needs upper level protol

***** Controller Logic
- controller selects "outgoing" IPv4 address range => base for sessions
- IPv4 addresses can be "random" (in our test case), but need
  to be unique
- switch does not need to know about the "range", only about
  sessions
- on session create, controller selects "random" ip (ring?)
- on session create, controller selects "random port" (next in range?)
- on session create controller adds choice into 2 tables:
  incoming, outgoing

>> ipaddress.IPv6Network("2001:db8:100::/96") [int(ipaddress.IPv4Address("10.0.0.1"))]
IPv6Address('2001:db8:100::a00:1')

```

from RFC6052

2.5 Protocol Checksums

One challenge for translating IPv6-IPv4 are checksums of higher level protocols like TCP and UDP that incorporate information from the lower level protocols. The pseudo header for upper layer protocols for IPv6 is defined in RFC2460 [15] and shown in figure 2.7, the IPv4 pseudo header for TCP and UDP are defined in RFC768 and RFC793 and are shown in 2.8. When



Figure 2.7: IPv6 Pseudo Header

translating, the checksum fields in the higher protocols need to be adjusted. The checksums for TCP and UDP is calculated not only over the pseudo headers, but also contain the payload of the packet. This is important, because some targets (like the NetPFGA) do not allow to access the payload.

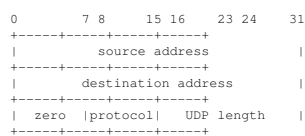

Figure 2.8: IPv4 Pseudo Header

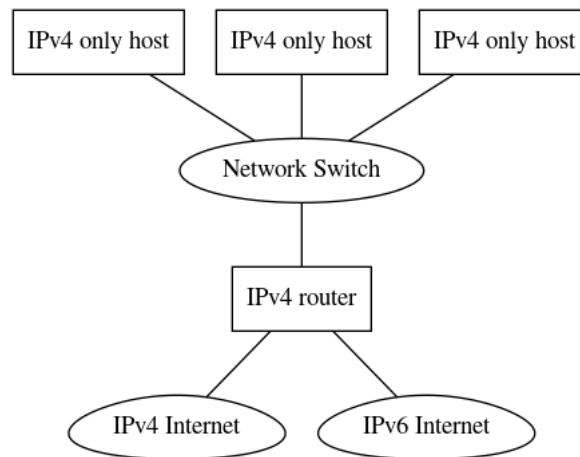

Figure 2.9: IPv4 only network

2.6 Network Designs

In relation to IPv6 and IPv4, there are in general three different network designs possible: The oldest form are IPv4 only networks (see figure 2.9). These networks consist of hosts that are either not configured for IPv6 or are even technically incapable of enabling the IPv6 protocol. These nodes are connected to an IPv4 router that is connected to the Internet. That router might be capable of translating IPv4 to IPv6 and vice versa. With the introduction of IPv6, hosts can

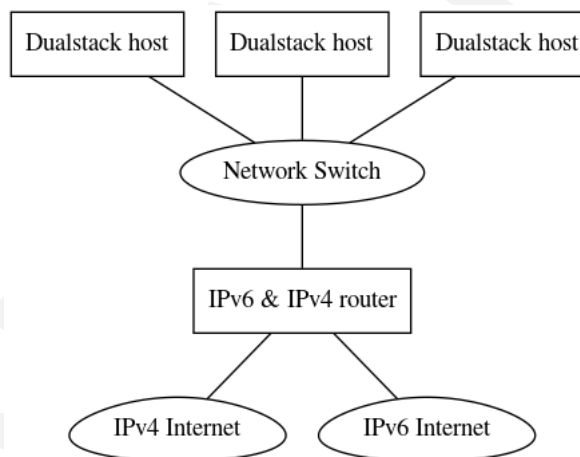

Figure 2.10: Dualstack network

have a separate IP stack active and in that configuration hosts are called “dualstack hosts” (see figure 2.10). Dualstack hosts are capable of reaching both IPv6 and IPv4 hosts directly without the need of any translation mechanism.

The last possible network design is based on IPv6 only hosts, as shown in figure 2.11. While it is technically easy to disable IPv4, it seems that completely removing the IPv4 stack in current operating systems is not an easy task [44]. While the three network designs look similar, there are significant differences in operating them and limitations that are not easy to circumvent. In the following sections we describe the limitations and reason how a translation mechanism like our NAT64 implementation should be deployed.

2.6.1 IPv4 only network limitations

As shown in figures 2.3 and 2.2 the IPv4 address size is 32 bit, while the IPv6 address size is 128 bit. Without an extension to the address space, there is no protocol independent mapping of IPv4 address to IPv6 (see section ??) that can cover the whole IPv6 address space. Thus

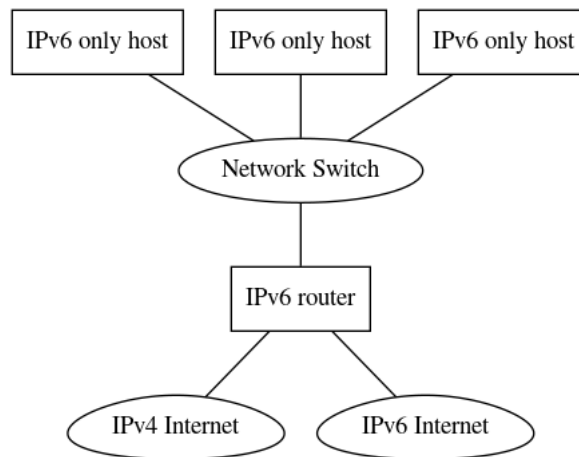

Figure 2.11: IPv6 only network

IPv4 only hosts can never address every host in the IPv6 Internet. While protocol dependent translations can try to minimise the impact, accessing all IPv6 addresses independent of the protocol is not possible.

2.6.2 Dualstack network maintenance

While dualstack hosts can address any host in either IPv6 or IPv4 networks, the deployment of dualstack hosts comes with a major disadvantage: all network configuration double. The required routing tables double, the firewall rules roughly double² and the number of network supporting systems (like DHCPv4, DHCPv6, router advertisement daemons, etc.) also roughly double. Additionally services that run on either IPv6 or IPv4 might need to be configured to run in dualstack mode as well and not every software might be capable of that. So while there is the instant benefit of not requiring any transition mechanism or translation method, we argue that the added complexity (and thus operational cost) of running dual stack networks can be significant.

2.6.3 IPv6 only networks

IPv6 only networks are in our opinion the best choice for long term deployments. The reasons for this are as follows: First of all hosts eventually will need to support IPv6 and secondly IPv6 hosts can address the whole 32 bit IPv4 Internet mapped in a single /96 IPv6 network. IPv6 only networks also allow the operators to focus on one IP stack.

²The rulesets even for identical policies in IPv6 and IPv4 networks are not identical, but similar. For this reason we state that roughly double the amount of firewall rules are required for the same policy to be applied.

DRAFT

Chapter 3

Design

Description of the theory/software/hardware that you designed. In this chapter we describe the architecture of our solution.

3.1 General - FIXME

The high level design can be seen in figure 3.1: a P4 capable switch is running our code to provide NAT64 functionality. The P4 switch cannot manage its tables on its own and needs support for this from a controller. If only static table entries are required, the controller can also be omitted. However stateful NAT64 requires the use of a control to create session entries in the switch tables. The P4 switch can use any protocol to communicate with controller, as the connection to

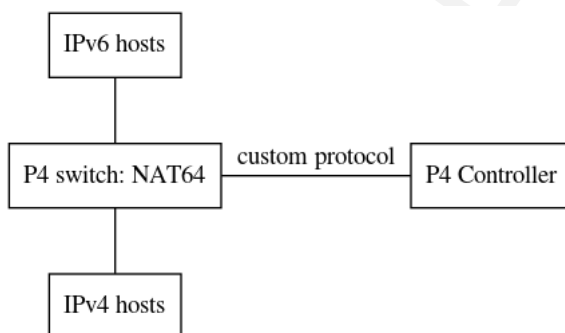

Figure 3.1: General Design

the controller is implemented as a separate ethernet port. The design allows our solution to be used as a standard NAT64 translation method or as an in network NAT64 translation (compare figures 1.3 and 1.4). The controller is implemented in python, the NAT64 solution is implemented in P4.

Describe network layouts

```
- IPv6 subnet 2001:db8::/32
- IPv6 hosts are in 2001:db8:6::/64
- IPv6 default router (::/0) is 2001:db8:6::42/64
- IPv4 mapped Internet "NAT64 prefix" 2001:db8:4444::/96 (should
go into a table)
- IPv4 hosts are in 10.0.4.0/24
- IPv6 in IPv4 mapped hosts are in 10.0.6.0/24
- IPv4 default router = 10.0.0.42
```

Describe testing methods

```
def test_v4_udp_to_v6(self):
    print('mx h3 "echo V4-OK | socat - UDP:10.1.1.1:2342"')
    print('mx h1 "echo V6-OK | socat - UDP-LISTEN:2342"')

    return

p4@ubuntu:~$ mx h1 "echo V6-OK | socat - UDP6-LISTEN:2342"
p4@ubuntu:~/master-thesis/bin$ mx h3 "echo V4-OK | socat - UDP:10.1.1.1:2342"

while true; do mx h3 "echo V4-OK | socat - TCP-LISTEN:2343"; sleep 2;
done
```

```
while true; do mx hl "echo V6-OK | socat -
TCP6:[2001:db8:1::a00:1]:2343"; sleep 2; done

mx hl "echo V6-OK | socat - TCP6:[2001:db8:1::a00:1]:2343"
```

3.2 BMV2

Development of the thesis took place on a software emulated switch that is implemented using Open vSwitch [17] and the behavioral model [9]. The development followed closely the general design shown in section 3.1. Within the software emulation checksums can be computed with two different methods:

- Recalculating the checksum by inspecting headers and payload
- Calculating the difference between the translated headers

The BMV2 model is rather sophisticated and provides many standard features including checksumming over payload. This allows the BMV2 model to operate as a full featured host, including advanced features like responding to ICMP6 Neighbor discovery requests [28] that include payload checksums. A typical code to create the checksum can be found in figure 3.2.

```
/* checksumming for icmp6_na_ns_option */
update_checksum_with_payload(meta.chk_icmp6_na_ns == 1,
{
    hdr.ipv6.src_addr,          /* 128 */
    hdr.ipv6.dst_addr,         /* 128 */
    meta.cast_length,         /* 32 */
    24w0,                      /* 24 0's */
    PROTO_ICMP6,              /* 8 */
    hdr.icmp6.type,            /* 8 */
    hdr.icmp6.code,           /* 8 */

    hdr.icmp6_na_ns.router,
    hdr.icmp6_na_ns.solicited,
    hdr.icmp6_na_ns.override,
    hdr.icmp6_na_ns.reserved,
    hdr.icmp6_na_ns.target_addr,

    hdr.icmp6_option_link_layer_addr.type,
    hdr.icmp6_option_link_layer_addr.ll_length,
    hdr.icmp6_option_link_layer_addr.mac_addr
},
hdr.icmp6.checksum,
HashAlgorithm.csum16
);
```

Figure 3.2: IPv4 Pseudo Header

3.3 NetFPGA

While the P4-NetFPGA project [29] allows compiling P4 to the NetFPGA, the design slightly varies. In particular, the NetFPGA P4 compiler does not support reading the payload. For this reason it also does not support creating the checksum based on the payload. To support checksum modifications in NAT64 on the NetFPGA, the checksum was calculated on the netpfga using differences between the IPv6 and IPv4 headers. Figure 3.3 shows an excerpt of the code used for calculating checksums in the netpfga. The checksums for IPv4, TCP, UDP and ICMP6 are all based on the “Internet Checksum” ([36], [10]). Its calculation can be summarised as follows:

The checksum field is the 16-bit one’s complement of the one’s complement sum of all 16-bit words in the header. For purposes of computing the checksum, the value of the checksum field is zero.¹

As the calculation mainly depends on (1-complement) sums, the checksums after translating the protocol can be corrected by subtracting the differences of the relevant fields. It is notable that not the full headers are used, but the pseudo headers (compare figures 2.7 and 2.8). To compensate the carry bit, our code uses 17 bit integers for correcting the carry.

¹Quote from Wikipedia[47].

```

action v4sum() {
    bit<16> tmp = 0;

    tmp = tmp + (bit<16>) hdr.ipv4.src_addr[15:0];           // 16 bit
    tmp = tmp + (bit<16>) hdr.ipv4.src_addr[31:16];        // 16 bit
    tmp = tmp + (bit<16>) hdr.ipv4.dst_addr[15:0];         // 16 bit
    tmp = tmp + (bit<16>) hdr.ipv4.dst_addr[31:16];        // 16 bit

    tmp = tmp + (bit<16>) hdr.ipv4.totalLen -20;           // 16 bit
    tmp = tmp + (bit<16>) hdr.ipv4.protocol;               // 8 bit

    meta.v4sum = ~tmp;
}

/* analogue code for v6sum skipped */
action delta_tcp_from_v6_to_v4()
{
    v6sum();
    v4sum();

    bit<17> tmp = (bit<17>) hdr.tcp.checksum + (bit<17>) meta.v4sum;
    if (tmp[16:16] == 1) {
        tmp = tmp + 1;
        tmp[16:16] = 0;
    }
    tmp = tmp + (bit<17>) (0xffff - meta.v6sum);
    if (tmp[16:16] == 1) {
        tmp = tmp + 1;
        tmp[16:16] = 0;
    }
}

hdr.tcp.checksum = (bit<16>) tmp;
}

```

Figure 3.3: Calculating checksum based on header differences

3.4 Benchmarks

The benchmarks were performed on two hosts, a load generator and a nat64 translator. Both hosts were equipped with a dual port Intel X520 10 Gbit/s network card. Both hosts were connected using DAC without any equipment in between. Figure 3.4 shows the setup. When testing

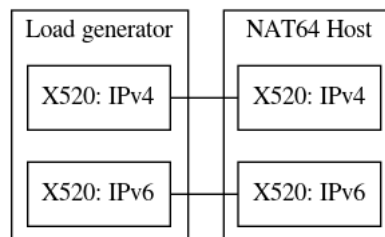

Figure 3.4: NAT64 in software benchmark

the NetPFGA/P4 performance, the X520 cards in the NAT64 translator were disconnected and instead the NetPFGA ports were connected, as show in figure 3.5. The load generator is equipped with a quad core CPU (Intel(R) Core(TM) i7-6700 CPU @ 3.40GHz), enabled with hyperthreading and 16 GB RAM. The NAT64 translator is also equipped with a quard core CPU (Intel(R) Core(TM) i7-4770 CPU @ 3.40GHz) and 16 GB RAM.

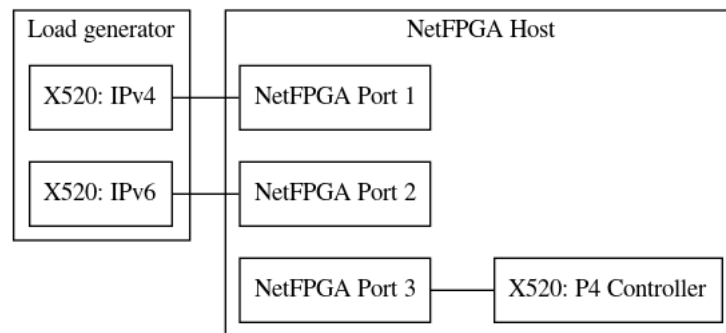

Figure 3.5: NAT64 with NetFPGA benchmark

Chapter 4

Results

This section describes the achieved results and compares the P4 based implementation with real world software solutions.

We distinguish the software implementation of P4 (BMV2) and the hardware implementation (NetFPGA) due to significant differences in deployment and development. We present benchmarks for the existing software solutions as well as for our hardware implementation. As the objective of this thesis was to demonstrate the high speed capabilities of NAT64 in hardware, no benchmarks were performed on the P4 software implementation.

4.1 NAT64 with P4

We successfully implemented P4 code to realise NAT64[42]. It contains parsers for all related protocols (ipv6, ipv4, udp, tcp, icmp, icmp6, ndp, arp), supports EAMT as defined by RFC7757 [3] and is feature equivalent to the two compared software solutions tayga[24] and jool[26]. Due to limitations in the P4 environment of the NetFPGA[?] environment, the BMV2 implementation is more feature rich. Table 4.1 summarises the achieved bandwidths of the NAT64 solutions.

Solution	Column 2 (additional line)	Column 3
Tayga	C2,R2	C2,R3
Jool	C2&C3,R3	
P4 / NetPFGA	C2,R4 ^a	C3,R4

^aFootnote to table 4.1

Table 4.1: Table 1

During the benchmarks the client

4.2 BMV2

Responds to icmp, icmp6 ndp [28] arp
test framework openvswitch

Fully functional host Can compute checksums on its own.

focus on typical use cases of icmp, icmp6, the software implementation supports translating echo request and echo reply messages, but does not support all ICMP/ICMP6 translations that are defined in RFC6145[23].

Stateful : no automatic removal

4.3 Tayga

3gbit

4.4 Jool

4.5 NetFPGA

4.5.1 Checksum computation

4.5.2 to be named

Trace files

```

create mode 100644 pcap/tcp-udp-delta-2019-07-17-1555-h1.pcap
create mode 100644 pcap/tcp-udp-delta-2019-07-17-1555-h3.pcap
create mode 100644 pcap/tcp-udp-delta-2019-07-17-1557-h1.pcap
create mode 100644 pcap/tcp-udp-delta-2019-07-17-1558-h3.pcap

*** DONE 2019-07-21: Proof of v6->v4 working delta based
CLOSED: [2019-07-21 Sun 12:30]
#+BEGIN_CENTER
pcap/tcp-udp-delta-from-v6-2019-07-21-0853-h1.pcap | Bin 0 -> 4252 bytes
pcap/tcp-udp-delta-from-v6-2019-07-21-0853-h3.pcap | Bin 0 -> 2544 bytes
#+END_CENTER

**** DONE Testing v4->v6 tcp: ok (version 10.0)
CLOSED: [2019-08-04 Sun 09:15]
#+BEGIN_CENTER
nico@ESPRIMO-P956:~/master-thesis/bin$ ./socat-connect-tcp-v4
+ echo from-v4-ok
+ socat - TCP:10.0.0.66:2345
TCPv6-ok
nico@ESPRIMO-P956:~/master-thesis/bin$ ./socat-listen-tcp-v6
from-v4-ok
#+END_CENTER

trace:
netfpga-nat64-2019-08-04-0907-emp2s0f0.pcap
netfpga-nat64-2019-08-04-0907-emp2s0f1.pcap

**** DONE Testing v4->v6 udp: ok (version 10.1)
trace:
create mode 100644 pcap/netfpga-nat64-udp-2019-08-04-0913-emp2s0f0.pcap
create mode 100644 pcap/netfpga-nat64-udp-2019-08-04-0913-emp2s0f1.pcap

*** DONE 2019-08-04: version 10.1/10.2: new maxpacketregion: v4->v6 works
CLOSED: [2019-08-04 Sun 19:42]
#+BEGIN_CENTER
nico@ESPRIMO-P956:~/master-thesis/bin$ ./init_ipv4_esprimo.sh
nico@ESPRIMO-P956:~/master-thesis/bin$ ./set_ipv4_neighbor.sh
#+END_CENTER

Test 20 first:

- Does't work -> missed to add table entries
- Does work after setting table entries
- 300 works
- 1450 works
- 1500 does not work

Proof:

create mode 100644 pcap/netfpga-10.2-maxpacket-2019-08-04-1931-emp2s0f0.pcap
create mode 100644 pcap/netfpga-10.2-maxpacket-2019-08-04-1931-emp2s0f1.pcap

*** DONE 2019-08-04: test v6 -> v4: works for 1420
CLOSED: [2019-08-04 Sun 20:30]

Proof:
#+BEGIN_CENTER
create mode 100644 pcap/netfpga-10.2-fromv6tov4-2019-08-04-1943-emp2s0f0.pcap
create mode 100644 pcap/netfpga-10.2-fromv6tov4-2019-08-04-1943-emp2s0f1.pcap

```

General result: limited NAT64 is working, however

No Payload checksumming - requires controller

Hash funktion in Arbeit

No NDP, no ARP - focused on key factors of NAT64 translation, other features can be supported by controller

4.6 NAT64 in Software

Tayga, Jool

tayga: Single threaded fork:

What?	Description	State in P4	References
Jool EAMT	Mapping with tables, multiple entries	Supported	https://www.jool.mx/en/eamt.html , https://www.jool.mx/en/run-eam.html , RFC 7757
Jool SIIT	Mapping IPv6 to range of IPv4, one entry	Supported by EAMT	

4.7 Feature comparison

speed - sessions - eamt can act as host lpm tables ping ping6 support ndp controller support

4.8 todo - FIXME: remove

**** Dorth eher detailliertes Drawing
**** Längste Section!

DRAFT

DRAFT

Chapter 5

Conclusion

Sum up what you have done and recapitulate your key findings.

5.1 Software based NAT64

5.2 General

Many misleading

5.3 BMV2

5.4 P4

NDP parsing problem

checksumming a frequent problem and helper

Many possibilities Protocol independent Easy architecture

Limitations in

if in action limitations

Limits if in actions

python2 only - unicode errors

IPv6: NDP: not easy to parse, as unknown number of following fields

No support for multiple LPM keys in a table, can be solved with ternary matching.

switch cannot be used in actions

if things don't work, often a checksum problem.

if frame checksum, then length of packet is broken

```
p4c -target bmv2 -arch vmodel -std p4-16 ../p4src/static-mapping.p4" -o "/home/p4/master-thesis/p4src"
../p4src/static-mapping.p4(366): error: Program is not supported by this target, because table MyIngress.v6_networks has multiple successors
    table v6_networks {
        ^^^^^^^^^^^
```

```
ipaddress.ip_network("2001:db8:61::/64")
IPv6Network(u'3230:3031:3a64:6238:3a36:313a:3a2f:3634/128')
```

```
Fix:
from __future__ import unicode_literals
```

The tooling around P4 is still fragile, encountered many bugs in the development.[41]

or missing features ([40], [43])

Hitting expression bug

retrieving information from tables

```
Key and mask for matching destination is in table. We need this
information in the action. However this information is not exposed, so
we need to specify another parameter with the same information as in
the key(s).
```

Log from slack: (2019-03-14)

nico [1:55 PM]

If I use LPM for matching, can I easily get the network address from P4 or do I have to use a bitmask myself? In the latter case it is not exactly clear how to get the ma

```

Nate Foster [1:58 PM]
You want to retrieve the address in the packet? In a table?
And do you want to do the retrieving from the data plane or the control plane? (edited)

nico [2:00 PM]
If I have a match in a table that matches on LPM, it can be any IP address in a network
For calculating the NAT64/NAT46 translation, I will need the base address, i.e. network address to do subtractions/additions
So it is fully data plane, what I would like to do
I'll commit sample code to show the use case more clearly
https://gitlab.ethz.ch/nicosc/master-thesis/blob/master/p4src/static-mapping.p4#L73
GitLab
p4src/static-mapping.p4 · master · nicosc / master-thesis
gitlab.ethz.ch
So the action nat64_static() is used in the table v6_networks.
In v6_networks I use a match on 'hdr.ipv6.dst_addr: lpm;'
What I would like to be able is to get the network address ; I can do that manually, if I have the mask
I can also re-inject this parameter by another action argument, but I'd assume that I can somewhere read this out from the table / match

Nate Foster [2:15 PM]
To make sure I understand, in the data plane, you want to retrieve the address in the lpm pattern? (edited)

nico [2:16 PM]
I want to retrieve the key

Nate Foster [2:16 PM]
Wait. The value 'hdr.ipv6.dst_addr' is the thing used in the match.
So you have that.
What you don't have is the IPv6 address and mask put into the table by the control plane.
I assume you want the latter, right?

nico [2:17 PM]
For example, if my matching key is 2001:db8::/32 and the real address is 2001:db8::f00, then I would like to retrieve 2001:db8:: and 32 from the table
exactly :slightly_smiling_face:
I can "Fix" this by adding another argument, but it feels somewhat wrong to do that
Because the table already knows this information

Nate Foster [2:26 PM]
I can't think of a way other than the action parameter hack.

nico [2:26 PM]
Oh, ok
Is it because the information is "lost in hardware"?

Nate Foster [2:31 PM]
No you're right that most implementations have the value in memory. And one can imagine a different table API that allowed one to retrieve it in the data plane.
But unless I am missing something obvious, P4 hides it...

```

no meta information

Is there any meta information for "from which table was the action called" available? My use case is having a debug action that sends packets to the controller and I use it as a default_action in various tables; however know I don't know anymore from which table the action was called. Is there any kind of meta information which table called me available?

```

I could work around this by using if(! .. .hit) { my_action(table_id)
}, but it would not work with using default_action = ...

```

type definitions separate Code sharing (controller, switch)

```

*** DONE Synchronisation with the controller
- Double data type definition -> might differ
- TYPE_CPU for ethernet
- Port ingress offset (9 vs. 16 bit)

```

No switch in actions, No conditional execution in actions

P4os - reusable code

Not addressed so far: how to create re-usable code fragments that can be plugged in easily. There could be a hypothetical "P4OS" that manages code fragments. This might include, but not limited to downloading (signed?) source code, managing dependencies similar to Linux package management, handling updates, etc.

idiomatic problem: Security issue: not checking checksums before

5.5 NetFGPA - all HERE

personal note here

tested various kernels for table debugging

MTU limitations: 1500 according to a private mail from Salvator Galea cambridge / uk

long compile process error prone compile process many dependencies lpm not supported!

Netpfga live, Vivado SDNET xx k lines of supporting code

Vivado installation: silent errors, infinite loop, missing libncurses5

82k lines of code that are interdependent Many non critical error messages on the way Zero exit

fatal errors

missing / spreaded documentation

tcpdump on local nfX doesn't work -> can only debug on other endpoint

First card: Writing tables fails hardware debug shows some errors but hardware debug on correct card also shows some error Debug ioctl errors when writing table entries

Output all ports -> port mapping documented only in a testdata script

hwtest: Execution fails due to missing djtgcfg

no payload accessq

Many workarounds

Table size 63, table size 64,

Table entries require arguments of all possible actions, not only used one.

Compile time hours

Silent errors

Unclear errors: broken board

Due to the very fragile nature of the build framework from the NetFPGA-Live repository,

Renaming VARIABLES in the definition of

Reproducibility:

hours for finding right output ports

packet size / annotation

Needed to debug internal parsing errors

3x rebooting to get card working with bitstream

Variable renaming breaks the compile process

It seems I was really mistaken for the last weeks

If I am not totally mistaken, the following is happening with the netpfga:

I was testing sending and receiving packets on the same computer; so I sent a packet on nfX and expected an answer on nf0, which is how I wanted to verify that the card works

So I ran tcpdump on nf0, send a packet with ping6 and scapy on nf{0,1,2,3} (edited)

I have never seen the switch emitting ANY packet back with tcpdump

Now with the card connected to another host, sending neighbor solicitation, I see duplicated packets on the other host - so it seems that it might have worked all the time.

debugging generated tcl code to debug impl1 error

Cable problems:

```
[ 488.265148] ixgbe 0000:02:00.0: failed to initialize because an unsupported SFP+ module type was detected.
[ 488.265157] ixgbe 0000:02:00.0: Reload the driver after installing a supported module.
[ 488.265605] ixgbe 0000:02:00.0: removed PHY on enp2s0f0
```

function syntax not supported, using defines instead

4-6 MB logfiles for a compile process.

confusing messages

```
WARNING: command 'get_user_parameter' will be removed in the 2015.3
release, use 'get_user_parameters' instead
```

critical non critical errors

```
CRITICAL WARNING: [BD 41-737] Cannot set the parameter TRANSLATION_MODE on /axi_interconnect_0. It is read-only.
```

```
- step9 (sume simulation, the longest step) in the process calls
  "config_writes.py"
- config_writes.py fails with a syntax error, as it is incomplete
  python code
- config_writes.py and config_writes.sh are generated by
  gen_config_writes.py
- gen_config_writes.py reads config_writes.txt
- config_writes.txt is created in step 5 (sdnet simulation)
- step 5 consists of running xsc, xelab and xsim
- xsim (re-)generates config_writes.txt according to a watch ls -l
  on the file: ${XILINX_VIVADO}/bin/xsim -runall
  SimpleSumeSwitch_tb#work.glbl
- it seems (by grep -r) that ./Testbench/SimpleSumeSwitch_tb.sv is
  responsible for writing config_writes.txt
- It seems that the "task" "SV_write_control" inside that file is
  responsible for writing the content, which in turn uses
  axi4_lite_master_write_request_control
```

```
- Cannot easily run P4 on notebook - changes to the system very
  invasive
- Various compiler bugs/limitations
- Very very deep rabbit hole problems
- Hanging/sleeping issue - unclear whether it does something or
  not
- Open impl1 error with unclear reason
- logfiles referenced that don't exist
```

```
Run output will be captured here: /home/nico/projects/P4-NetFPGA/contrib-projects/sume-sdnet-switch/projects/minip4/simple_sume_switch/hw/project/simple_sume_switch.runs/sy
nico@nsg-System:~/master-thesis/netpfga/minip4/testdata$ ls -alh /home/nico/projects/P4-NetFPGA/contrib-projects/sume-sdnet-switch/projects/minip4/simple_sume_switch/hw/project/simple
ls: cannot access '/home/nico/projects/P4-NetFPGA/contrib-projects/sume-sdnet-switch/projects/minip4/simple_sume_switch/hw/project/simple_sume_switch.runs/synth/runme.log'
- even "short" compile runs taking 30m+
```

```
control_sub_m02_data_fifo_0_synth_1: /home/nico/projects/P4-NetFPGA/contrib-projects/sume-sdnet-switch/projects/minip4/simple_sume_switch/hw/project/simple_sume_switch.runs/sy
nico@nsg-System:~/master-thesis/netpfga/minip4/testdata$ less /home/nico/projects/P4-NetFPGA/contrib-projects/sume-sdnet-switch/projects/minip4/simple_sume_switch/hw/project/simple
/home/nico/projects/P4-NetFPGA/contrib-projects/sume-sdnet-switch/projects/minip4/simple_sume_switch/hw/project/simple_sume_switch.runs/control_sub_m02_data_fifo_0_synth_1
```

```
- Wrong warnings: using 2018.2, getting warnings about things
  removed in 2015.3
```

```
WARNING: command 'get_user_parameter' will be removed in the 2015.3
```

release, use 'get_user_parameters' instead

- A script/makefile generates a python script that generates a shell script and later then a python script. If there is a mistake in generating the first python script (syntax ok, but content is not correct) then a much later stage of the compile process will fail due to a syntax error in the third generated script. However that syntax error is not fatal in the build process and thus can only be seen with careful analysis of the logfile, which is around 700 KiB or 10k lines per compile process and contains 328 lines matching "error" and "warning".

Most of the error and warning messages seem to be non-critical (even if saying they are). Then there are a variety of INFO messages that actually constitute ERROR messages, but are not flagged as such nor do they cause the build process to abort.

LPM tables don't work

match type exact - table must be at least 64 in size

multiple reboots sometimes required for flashing

Damaged, enlarged packets

** The NetPFGA saga

Problems encountered:

- The logfile for a compile run is 10k+ lines
- Many logged errors can actually be ignored (?) like:

```
ERROR: [VRFC 10-1491] unexpected EOF [/home/nico/master-thesis/netpfga/minip4/nf_sume_sdnet_ip/SimpleSumeSwitch/S_CONTROLLERs.HDL/S_CONTROLLER_SimpleSumeSwitch.vp:37]
ERROR: [VRFC 10-426] cannot find port tuple_out_sume_metadata_DATA on this module [/home/nico/master-thesis/netpfga/minip4/simple_sume_switch/hw/project/simple_sume_sw
ERROR: [VRFC 10-426] cannot find port tuple_out_sume_metadata_VALID on this module [/home/nico/master-thesis/netpfga/minip4/simple_sume_switch/hw/project/simple_sume_sw
ERROR: [VRFC 10-426] cannot find port tuple_in_sume_metadata_DATA on this module [/home/nico/master-thesis/netpfga/minip4/simple_sume_switch/hw/project/simple_sume_sw
ERROR: [VRFC 10-426] cannot find port tuple_in_sume_metadata_VALID on this module [/home/nico/master-thesis/netpfga/minip4/simple_sume_switch/hw/project/simple_sume_sw
ERROR: [VRFC 10-2063] Module <S_RESETTER_line> not found while processing module instance <S_RESET_clk_line> [/home/nico/master-thesis/netpfga/minip4/simple_sume_switc
leSumeSwitch/SimpleSumeSwitch.v:332]
ERROR: [VRFC 10-2063] Module <S_RESETTER_lookup> not found while processing module instance <S_RESET_clk_lookup> [/home/nico/master-thesis/netpfga/minip4/simple_sume_sw
SimpleSumeSwitch/SimpleSumeSwitch.v:343]
ERROR: [VRFC 10-2063] Module <S_RESETTER_control> not found while processing module instance <S_RESET_clk_control> [/home/nico/master-thesis/netpfga/minip4/simple_sume_sw
p/SimpleSumeSwitch/SimpleSumeSwitch.v:354]
ERROR: [VRFC 10-2063] Module <TopParser_t> not found while processing module instance <TopParser> [/home/nico/master-thesis/netpfga/minip4/simple_sume_switch/hw/proje
h/SimpleSumeSwitch.v:436]
ERROR: [VRFC 10-2063] Module <TopPipe_lv1_t> not found while processing module instance <TopPipe_lv1> [/home/nico/master-thesis/netpfga/minip4/simple_sume_switch/hw/p
witch/SimpleSumeSwitch.v:474]
ERROR: [VRFC 10-2063] Module <dummy_table_for_netpfga_t> not found while processing module instance <dummy_table_for_netpfga> [/home/nico/master-thesis/netpfga/minip4
ume_sdnet_ip/SimpleSumeSwitch/SimpleSumeSwitch.v:502]
ERROR: [VRFC 10-2063] Module <TopPipe_lv1_0_t> not found while processing module instance <TopPipe_lv1_0> [/home/nico/master-thesis/netpfga/minip4/simple_sume_switch/h
umeSwitch/SimpleSumeSwitch.v:533]
ERROR: [VRFC 10-2063] Module <TopDeparser_t> not found while processing module instance <TopDeparser> [/home/nico/master-thesis/netpfga/minip4/simple_sume_switch/hw/p
witch/SimpleSumeSwitch.v:561]
```

```
# launch_simulation -simset sim_1 -mode behavioral
```

```
INFO: [Vivado 12-5698] Checking validity of IPs in the design for the 'XSim' simulator...
```

```
CRITICAL WARNING: [BD 41-1356] Address block </M04_AXI/Reg> is not mapped into </S00_AXI>. Please use Address Editor to either map or exclude it.
```

```
CRITICAL WARNING: [BD 41-1356] Address block </M05_AXI/Reg> is not mapped into </S00_AXI>. Please use Address Editor to either map or exclude it.
```

```
WARNING: [VRFC 10-756] identifier state is used before its declaration [/home/nico/master-thesis/netpfga/minip4/simple_sume_switch/hw/project/simple_sume_switch.srcs/s
```

```
WARNING: [VRFC 10-756] identifier ready_count is used before its declaration [/home/nico/master-thesis/netpfga/minip4/simple_sume_switch/hw/project/simple_sume_switch.
```

```
INFO: [#UNDEF] Sorry, too many errors..
```

```
ERROR: [XSIM 43-3322] Static elaboration of top level Verilog design unit(s) in library work failed.
```

```
INFO: [USF-XSim-69] 'elaborate' step finished in '1' seconds
```

```
INFO: [USF-XSim-99] Step results log file: '/home/nico/master-thesis/netpfga/minip4/simple_sume_switch/hw/project/simple_sume_switch.sim/sim_1/behav/xsim/elaborate.log'
```

```
ERROR: [USF-XSim-62] 'elaborate' step failed with error(s). Please check the Tcl console output or '/home/nico/master-thesis/netpfga/minip4/simple_sume_switch/hw/proje
```

```
nico@nsg-System:~/master-thesis$ find . -name elaborate.log
```

```
nico@nsg-System:~/master-thesis$ find ~ -name elaborate.log
```

```
nico@nsg-System:~/master-thesis$
```

- Scripts that "fail" (generate wrong data) do exit 0 ->

There is no easy / reliable error detection

- Writing tables resulted in ioctl errors

- Hardware test: unclear if first board was/is broken or not,

BUT: second board in different computer allows writing tables

- Many scripts depend on each other in later stages, without clear

dependencies

- There is basically no documentation for someone who "just wants to

compile from P4 to netpfga" or A LOT of documentation (if vivado,

vhld, sdnet documentation is counted)

- Very high complexity in toolchain, scripts that are generated

```
+ cd /home/nico/projects/P4-NetPFGA/contrib-projects/sume-sdnet-switch/projects/minip4/simple_sume_switch/test/sim_switch_default
```

```
+ make
```

```
rm -f config_writes.py*
```

```
rm -f *.pyc
```

```
nico@nsg-System:~$ cat /home/nico/projects/P4-NetPFGA/contrib-projects/sume-sdnet-switch/projects/minip4/testdata/config_writes.py
```

```
from NFTest import *
```

```
NUM_WRITES = 4
```

```
def config_tables():
```

```
    nftest_regwrite(0x44020050, 0x22222208)
```

```
    nftest_regwrite(0x44020054, 0x00000822)
```

```
    nftest_regwrite(0x44020080, 0x00000201)
```

```
    nftest_regwrite(0x44020040, 0x00000001)
```

```
nico@nsg-System:~$ cat /home/nico/projects/P4-NetPFGA/contrib-projects/sume-sdnet-switch/projects/minip4/testdata/config_writes.sh
```

```
#!/bin/bash
```

```
$(SUME_SDNET)/sw/sume/rwaxi -a 0x44020050 -w 0x22222208
```

```
$(SUME_SDNET)/sw/sume/rwaxi -a 0x44020054 -w 0x00000822
```

```
$(SUME_SDNET)/sw/sume/rwaxi -a 0x44020080 -w 0x00000201
```

```
$(SUME_SDNET)/sw/sume/rwaxi -a 0x44020040 -w 0x00000001
```

```
nico@nsg-System:~$
```

- Misleading errors like

```
ERROR: [USF-XSim-62] 'elaborate' step failed with error(s). Please check the Tcl console output or '/home/nico/master-thesis/netpfga/minip4/simple_sume_switch/hw/proje
```

```
nico@nsg-System:~/master-thesis/netpfga$ ls /home/nico/master-thesis/netpfga/minip4/simple_sume_switch/hw/project/simple_sume_switch.sim/sim_1/behav/xsim/elaborate.log
```



```

ls: cannot access '/home/nico/master-thesis/netpfga/minip4/simple_sume_switch/hw/project/simple_sume_switch.sim/sim_1/behav/xsim/elaborate.log': No such file or directory
- not using raise() and hiding source of errors (_hexify)
- sometimes flashing fails:

#+BEGIN_CENTER
nico@nsg-System:~/projects/P4-NetPPGA/contrib-projects/sume-sdnet-switch/projects/minip4/simple_sume_switch/bitfiles$ sudo bash -c ". $HOME/master-thesis/netpfga/bashinit
++ which vivado
+ xilinx_tool_path=/opt/Xilinx/Vivado/2018.2/bin/vivado
+ bitimage=minip4.bit
+ configWrites=config_writes.sh
+ '[' -z minip4.bit ']'
+ '[' -z config_writes.sh ']'
+ '[' /opt/Xilinx/Vivado/2018.2/bin/vivado == " ']'
+ rmdir sume_riffa
+ xsct /home/nico/projects/P4-NetPPGA/contrib-projects/sume-sdnet-switch/tools/run_xsct.tcl -tclargs minip4.bit
rlwrap: warning: your $TERM is 'screen' but rlwrap couldn't find it in the terminfo database. Expect some problems.
RUN loading image file.
minip4.bit
100% 19MB 1.7MB/s 00:11
fpga configuration failed. DONE PIN is not HIGH
invoked from within
":tcf::eval -progress ::xsdb::print_progress (:tcf::cache_enter tcfchan#0 (tcf_cache_eval (process_tcf_actions_cache_client ::tcfclient#0::arg)))"
(procedure ":tcf::cache_eval_with_progress" line 2)
invoked from within
":tcf::cache_eval_with_progress [dict get $arg chan] [list process_tcf_actions_cache_client $argvar] $progress"
(procedure "process_tcf_actions" line 1)
invoked from within
"process_tcf_actions $arg ::xsdb::print_progress"
(procedure "fpga" line 430)
invoked from within
"fpga -f $bitimage"
(file "/home/nico/projects/P4-NetPPGA/contrib-projects/sume-sdnet-switch/tools/run_xsct.tcl" line 33)

+ bash /home/nico/projects/P4-NetPPGA/contrib-projects/sume-sdnet-switch/tools/pci_rescan_run.sh
Check programming FPGA or Reboot machine !
+ rmdir sume_riffa
rmdir: ERROR: Module sume_riffa is not currently loaded
+ modprobe sume_riffa
+ ifconfig nf0 up
nf0: ERROR while getting interface flags: No such device
+ ifconfig nf1 up
nf1: ERROR while getting interface flags: No such device
+ ifconfig nf2 up
nf2: ERROR while getting interface flags: No such device
+ ifconfig nf3 up
nf3: ERROR while getting interface flags: No such device
+ bash config_writes.sh
nico@nsg-System:~/projects/P4-NetPPGA/contrib-projects/sume-sdnet-switch/projects/minip4/simple_sume_switch/bitfiles$

#+END_CENTER

```

5.6 Real world applications

Can be deployed using the netpfga. Or Barefoot or Arista.

5.7 Outlook

What are the consequences of your work for future work?

Different HW

Speed only limited to line speed. Could be running at 100 Gbit/s without modifications.

PMTU handling error cases

Our algorithm uses the IPv4-Compatible IPv6 Address[19] to embed IPv4 addresses. However RFC6052[7] defines different embeddings depending on the prefix size. A future version should support these schemes to be compatible to other implementations.

No fragmentation No address / mac learning

**** No DNS64 has already been solved in a different domain - could even do transparent / in network modification **** Incomplete NDP Very limited option support

No resolution of hardware addresses

5.8 Closing words (NAME?)

While the port to NetPPGA was significantly more effort then expected, the learnings of the different layers were very much appreciated / liked

It was a

5.9 todo - FIXME: remove

**** Summary eher kurz

***** Outlook als subsection!

DRAFT

Appendix A

Resources and code repositories

The following sections describe how to acquire the resources to reproduce the test results. All compilations were made on Ubuntu 16.04 with kernels

- 4.15.0-54-generic (Supporting Desktop)
- 4.4.0-143-generic (BMV2 test VM)
- 4.15.0-55-generic (Desktop with NetFPGA card)

A.1 Master Thesis

The master thesis including all self developed source code is available by git via

```
git clone git@gitlab.ethz.ch:nicosc/master-thesis.git
git clone https://gitlab.ethz.ch/nsg/student-projects/ma-2019-19_high_speed_nat64_with_p4
```

It can be browsed online on <https://gitlab.ethz.ch/nicosc/master-thesis> and on https://gitlab.ethz.ch/nsg/student-projects/ma-2019-19_high_speed_nat64_with_p4.

A.2 Xilinx Toolchain

A prerequisite for building the NetFPGA source code is the installation of

- Xilinx_SDNNet_2018.2_1005_9
- Xilinx_Vivado_SDK_2018.2_0614_1954

Both tools need to be installed to `/opt/Xilinx/`, as paths are hardcoded in various places.

A.3 NetFPGA support scripts

To be able to compile P4 source code to the NetFPGA the collection of scripts, Makefiles and sample code of P4-NetFPGA is required.

The repository `git@github.com:NetFPGA/P4-NetFPGA-live.git` needs to be cloned to “projects” subdirectory as “P4-NetPFGA” of the user that wants to compile the source code. Access to the repository is granted after applying for access as described on <https://github.com/NetFPGA/P4-NetFPGA-public/wiki>. After that the variable `P4_PROJECT_NAME` in `/projects/P4-NetFPGA/tools/settings.sh` needs to be modified to read `export P4_PROJECT_NAME=minip4` instead of `export P4_PROJECT_NAME=switch_calc`. Sample code for installation:

```
mkdir -p ~/projects
git clone git@github.com:NetFPGA/P4-NetFPGA-live.git P4-NetFPGA
sed -i 's/(P4_PROJECT_NAME=).*\/lminip4/' ~/projects/P4-NetFPGA/tools/settings.sh
```

Version **v1.3.1-46-g97d3aaa** of the P4-NetPFGA repository was used for creating the bitfiles of this project.

```
nico@nsg-System:~/projects/P4-NetFPGA$ git describe --always
v1.3.1-46-g97d3aaa
```

DRAFT

Appendix B

BMV2 environment and tests

All BMV2 based compilations were made with the following compiler:

```
p4@ubuntu:~$ p4c -version
p4c 0.5 (SHA: 5ae30ee)
```

The installation is based on the vagrant files that were provided in the “Advanced Topics in Communication Networks Fall 2018” course of ETHZ (<https://adv-net.ethz.ch/2018/>) and contains p4tools as well as all utilities that came with the vagrant installation. For running the diff based checksum code, the following steps are necessary:

Compiling the p4 code and starting the switch:

```
cd ~/master-thesis/p4app
sudo p4run -config nat64-diff.json
```

Starting the controller which sets up the required table entries:

```
cd ~/master-thesis/p4app
sudo python ./controller.py -mode range_router
```

DRAFT

Appendix C

NetFPGA environment and tests

C.1 NetFPGA Setup

Description of installation, commit of netfpga-live

C.2 NetFPGA Compile Flow

C.3 NetFPGA NAT64 Test cases

todo: add graphic of nsg <-> esprimo cabling

```
ip addr add 10.0.0.42/24 dev enp2s0f0

# Adding necessary ARP entries: for the virtual IPv4 address(es)
ip neigh add 10.0.0.6 lladdr f8:f2:1e:09:62:d1 dev enp2s0f0
ip neigh add 10.0.0.42 lladdr f8:f2:1e:09:62:d1 dev enp2s0f0
```

For all test cases the following network settings on esprimo:

```
12: enp2s0f0: <BROADCAST,MULTICAST,UP,LOWER_UP> mtu 1500 qdisc mq state UP group default qlen 1000
    link/ether f8:f2:1e:09:62:d0 brd ff:ff:ff:ff:ff:ff
    inet 10.0.0.42/24 scope global enp2s0f0
        valid_lft forever preferred_lft forever
    inet6 fe80::faf2:1eff:fe09:62d0/64 scope link
        valid_lft forever preferred_lft forever
13: enp2s0f1: <BROADCAST,MULTICAST,UP,LOWER_UP> mtu 1500 qdisc mq state UP group default qlen 1000
    link/ether f8:f2:1e:09:62:d1 brd ff:ff:ff:ff:ff:ff
    inet6 2001:db8:42::42/64 scope global
        valid_lft forever preferred_lft forever
    inet6 fe80::faf2:1eff:fe09:62d1/64 scope link
        valid_lft forever preferred_lft forever
```

C.3.1 Test 1: IPv4 egress

Scenario: simple egress port setting for the IPv4 addresses

Step 1: getting correct values for table entries from python:

```
>>> int(ipaddress.IPv4Address(u"10.0.0.42"))
167772202
>>> int(ipaddress.IPv4Address(u"10.0.0.4"))
167772164
>>>
```

Step 2: setting table entries

```
> table_cam_add_entry realmain_v4_networks_0 realmain.set_egress_port 167772202 => 16 0 0 0 0
fields = [(u'hit', 1), (u'action_run', 3), (u'out_port', 8), (u'out_port', 8), (u'mac_addr', 48), (u'task', 16), (u'table_id', 16)]
action_name = TopPipe.realmain.set_egress_port
field_vals = [1, '16', '0', '0', '0', '0']
CAM_Init_ValidateContext() - done
WROTE 0x44020250 = 0xa00002a
WROTE 0x44020280 = 0x0000
WROTE 0x44020284 = 0x0000
WROTE 0x44020288 = 0x10000000
WROTE 0x4402028c = 0x0001
READ 0x44020244 = 0x0001
WROTE 0x44020240 = 0x0001
READ 0x44020244 = 0x0001
READ 0x44020244 = 0x0001
success
> table_cam_add_entry realmain_v4_networks_0 realmain.set_egress_port 167772164 => 16 0 0 0 0
```

```

fields = [(u'hit', 1), (u'action_run', 3), (u'out_port', 8), (u'out_port', 8), (u'mac_addr', 48), (u'task', 16), (u'table_id', 16)]
action_name = TopPipe.realmmain.set_egress_port
field_vals = [1, '16', '0', '0', '0', '0']
CAM_Init_ValidateContext() - done
WROTE 0x44020250 = 0xa000004
WROTE 0x44020280 = 0x0000
WROTE 0x44020284 = 0x0000
WROTE 0x44020288 = 0x10000000
WROTE 0x4402028c = 0x0001
READ 0x44020244 = 0x0001
WROTE 0x44020240 = 0x0001
READ 0x44020244 = 0x0001
READ 0x44020244 = 0x0001
success
»

```

Step 3: setting arp entries

```

root@ESPRIMO-P956:~# ip neigh add 10.0.0.6 lladdr f8:f2:1e:09:62:d1 dev enp2s0f0
root@ESPRIMO-P956:~# ip neigh add 10.0.0.4 lladdr f8:f2:1e:09:62:d1 dev enp2s0f0

```

Step 3: generating test packets, expecting 4 packets to show up on enp2s0f0:

```

nico@ESPRIMO-P956:~$ sudo tcpdump -ni enp2s0f0
tcpdump: verbose output suppressed, use -v or -vv for full protocol decode
listening on enp2s0f0, link-type EN10MB (Ethernet), capture size 262144 bytes
10:49:28.200407 IP 10.0.0.42 > 10.0.0.4: ICMP echo request, id 4440, seq 1, length 64
10:49:28.200445 IP 10.0.0.42 > 10.0.0.4: ICMP echo request, id 4440, seq 1, length 64
10:49:29.222340 IP 10.0.0.42 > 10.0.0.4: ICMP echo request, id 4440, seq 2, length 64
10:49:29.222418 IP 10.0.0.42 > 10.0.0.4: ICMP echo request, id 4440, seq 2, length 64

```

Result: success

C.3.2 Test 2: IPv6 egress

Similar to the IPv4 setting before, just for IPv6.

Step 1: getting IP address values

```

>> int(ipaddress.IPv6Address(u"2001:db8:42::4"))
42540766411362381960998550477184434180L
>> int(ipaddress.IPv6Address(u"2001:db8:42::6"))
42540766411362381960998550477184434182L
>> int(ipaddress.IPv6Address(u"2001:db8:42::42"))
42540766411362381960998550477184434242L

```

Step 2: setting table entries

```

» table_cam_add_entry realmmain_v6_networks_0 realmmain.set_egress_port 42540766411362381960998550477184434242 => 64 0 0 0
fields = [(u'hit', 1), (u'action_run', 3), (u'out_port', 8), (u'out_port', 8), (u'mac_addr', 48), (u'task', 16), (u'table_id', 16)]
action_name = TopPipe.realmmain.set_egress_port
field_vals = [1, '64', '0', '0', '0', '0']
CAM_Init_ValidateContext() - done
WROTE 0x44020350 = 0x0006
WROTE 0x44020354 = 0x0000
WROTE 0x44020358 = 0x420000
WROTE 0x4402035c = 0x20010db8
WROTE 0x44020380 = 0x0000
WROTE 0x44020384 = 0x0000
WROTE 0x44020388 = 0x40000000
WROTE 0x4402038c = 0x0001
READ 0x44020344 = 0x0001
WROTE 0x44020340 = 0x0001
READ 0x44020344 = 0x0001
READ 0x44020344 = 0x0001
success
» table_cam_add_entry realmmain_v6_networks_0 realmmain.set_egress_port 42540766411362381960998550477184434242 => 64 0 0 0
fields = [(u'hit', 1), (u'action_run', 3), (u'out_port', 8), (u'out_port', 8), (u'mac_addr', 48), (u'task', 16), (u'table_id', 16)]
action_name = TopPipe.realmmain.set_egress_port
field_vals = [1, '64', '0', '0', '0', '0']
CAM_Init_ValidateContext() - done
WROTE 0x44020350 = 0x0042
WROTE 0x44020354 = 0x0000
WROTE 0x44020358 = 0x420000
WROTE 0x4402035c = 0x20010db8
WROTE 0x44020380 = 0x0000
WROTE 0x44020384 = 0x0000
WROTE 0x44020388 = 0x40000000
WROTE 0x4402038c = 0x0001
READ 0x44020344 = 0x0001
WROTE 0x44020340 = 0x0001
READ 0x44020344 = 0x0001
READ 0x44020344 = 0x0001
success
»

```

Step 3: setting neighbor entries

```

nico@ESPRIMO-P956:~$ sudo ip -6 neigh add 2001:db8:42::6 lladdr f8:f2:1e:09:62:d0 dev enp2s0f1
nico@ESPRIMO-P956:~$ sudo ip -6 neigh add 2001:db8:42::4 lladdr f8:f2:1e:09:62:d0 dev enp2s0f1

```

Step 4: generating test packets

```
nico@ESPRIMO-P956:~$ ping6 -c2 2001:db8:42::6
PING 2001:db8:42::6 (2001:db8:42::6) 56 data bytes
```

```
nico@ESPRIMO-P956:~$ sudo tcpdump -ni enp2s0f1
tcpdump: verbose output suppressed, use -v or -vv for full protocol decode
listening on enp2s0f1, link-type EN10MB (Ethernet), capture size 262144 bytes
11:30:17.287577 IP6 2001:db8:42::42 > 2001:db8:42::6: ICMP6, echo request, seq 1, length 64
11:30:17.287599 IP6 2001:db8:42::42 > 2001:db8:42::6: ICMP6, echo request, seq 1, length 64
11:30:18.310178 IP6 2001:db8:42::42 > 2001:db8:42::6: ICMP6, echo request, seq 2, length 64
11:30:18.310258 IP6 2001:db8:42::42 > 2001:db8:42::6: ICMP6, echo request, seq 2, length 64
```

Result: success, packet is seen twice.

C.3.3 Test 3: NAT64

Additionally to the preparations done in test 1 and 2, the following steps were taken:

Step 1: getting IP address values via Python

```
>> int(ipaddress.IPv6Address(u"2001:db8:42::2a"))
42540766411362381960998550477184434216L

>> int(ipaddress.IPv6Address(u"2001:db8:42::"))
42540766411362381960998550477184434176L

>> int(ipaddress.IPv6Address(u"2001:db8:42::a00:2a"))
42540766411362381960998550477352206378

>> int(ipaddress.IPv4Address(u"10.0.0.0"))
167772160

>> int(ipaddress.IPv4Address(u"10.0.0.66"))
167772226
```

Add table entry for 2001:db8:42:2a to be translated to 10.0.0.42:

```
>> table_cam_add_entry realmain_nat64_0 realmain_nat64_static 42540766411362381960998550477184434216 => 42540766411362381960998550477184434176 167772160 42540766411362381960998550477184434176
fields = [(u'hit', 1), (u'action_run', 3), (u'v6_src', 128), (u'v4_dst', 32), (u'nat64_prefix', 128), (u'table_id', 16)]
action_name = TopPipe.realmain_nat64_static
field_vals = [2, '42540766411362381960998550477184434176', '167772160', '42540766411362381960998550477184434176', '0']
CAM_Init_ValidateContext() - done
WROTE 0x44020050 = 0x002a
WROTE 0x44020054 = 0x0000
WROTE 0x44020058 = 0x420000
WROTE 0x4402005c = 0x20010db8
WROTE 0x44020080 = 0x0000
WROTE 0x44020084 = 0x0000
WROTE 0x44020088 = 0x0000
WROTE 0x4402008c = 0xdb80042
WROTE 0x44020090 = 0x2001
WROTE 0x44020094 = 0x0a00
WROTE 0x44020098 = 0x0000
WROTE 0x4402009c = 0x0000
WROTE 0x440200a0 = 0xdb80042
WROTE 0x440200a4 = 0x22001
READ 0x44020044 = 0x0001
WROTE 0x44020040 = 0x0001
READ 0x44020044 = 0x0001
READ 0x44020044 = 0x0001
success
>>
```

Add table entry for 2001:db8:42:a00:2a to be translated to 10.0.0.66:

```
table_cam_add_entry realmain_nat64_0 realmain_nat64_static 42540766411362381960998550477352206378 => 42540766411362381960998550477184434176 167772160 42540766411362381960998550477184434176
```

Add table entry for 10.0.0.66 to be translated to 2001:db8:42:42:

```
>> table_cam_add_entry realmain_nat46_0 realmain_nat46_static 167772226 => 42540766411362381960998550477184434176 167772160 42540766411362381960998550477184434176 0
fields = [(u'hit', 1), (u'action_run', 3), (u'v6_src', 128), (u'v4_dst', 32), (u'nat64_prefix', 128), (u'table_id', 16)]
action_name = TopPipe.realmain_nat46_static
field_vals = [2, '42540766411362381960998550477184434176', '167772160', '42540766411362381960998550477184434176', '0']
CAM_Init_ValidateContext() - done
WROTE 0x44020150 = 0xa00042
WROTE 0x44020180 = 0x0000
WROTE 0x44020184 = 0x0000
WROTE 0x44020188 = 0x0000
WROTE 0x4402018c = 0xdb80042
WROTE 0x44020190 = 0x2001
WROTE 0x44020194 = 0x0a00
WROTE 0x44020198 = 0x0000
WROTE 0x4402019c = 0x0000
WROTE 0x440201a0 = 0xdb80042
WROTE 0x440201a4 = 0x22001
READ 0x44020144 = 0x0001
WROTE 0x44020140 = 0x0001
READ 0x44020144 = 0x0001
READ 0x44020144 = 0x0001
success
>>
```

Step 3: setting neighbor entries

```
sudo ip neigh add 10.0.0.66 lladdr f8:f2:1e:09:62:d1 dev enp2s0f0
sudo ip -6 neigh add 2001:db8:42::2a lladdr f8:f2:1e:09:62:d0 dev enp2s0f1
sudo ip -6 neighbor add 2001:db8:42::a00:2a lladdr f8:f2:1e:09:62:d0 dev enp2s0f1
```

Step 4: ping test should translate, but fail with wrong checksum:

DRAFT

Appendix D

NetFPGA Logs

Majority of the log files are stored inside the source code directory stored at “netpfga/logs”. It follows a selection of excerpts of log files that might be relevant for reproducing the work.

D.1 NetFPGA Flash Errors

Sometimes flashing bitfiles to the NetFPGA will fail. A random amount of reboots (1 to 3) and a random amount of reflashing will fix this problem.

Below can be found the log output from the flashing process.

```
nico@nsg-System:~/projects/P4-NetFPGA/contrib-projects/sume-sdnet-switch/projects/minip4/simple_sume_switch/bitfiles$ sudo bash -c ". $HOME/master-thesis/netpfga/bashinit
++ which vivado
+ xilinx_tool_path=/opt/Xilinx/Vivado/2018.2/bin/vivado
+ bitimage=minip4.bit
+ configWrites=config_writes.sh
+ '[' -z minip4.bit ']'
+ '[' -z config_writes.sh ']'
+ '[' /opt/Xilinx/Vivado/2018.2/bin/vivado == " ']'
+ rmdir sume_riffa
+ xsct /home/nico/projects/P4-NetFPGA/contrib-projects/sume-sdnet-switch/tools/run_xsct.tcl -tclargs minip4.bit
rlwrap: warning: your $TERM is 'screen' but rlwrap couldn't find it in the terminfo database. Expect some problems.
RUN loading image file.
minip4.bit
100% 19MB 1.7MB/s 00:11
fpga configuration failed. DONE PIN is not HIGH
invoked from within
":tcf::eval -progress ::xsdb::print_progress (:tcf::cache_enter tcfchan#0 {tcf_cache_eval {process_tcf_actions_cache_client ::tcfclient#0::arg}})"
  (procedure "":tcf::cache_eval_with_progress" line 2)
  invoked from within
":tcf::cache_eval_with_progress [dict get $arg chan] [list process_tcf_actions_cache_client $argvar] $progress"
  (procedure "process_tcf_actions" line 1)
  invoked from within
"process_tcf_actions $arg ::xsdb::print_progress"
  (procedure "fpga" line 430)
  invoked from within
"fpga -f $bitimage"
  (file "/home/nico/projects/P4-NetFPGA/contrib-projects/sume-sdnet-switch/tools/run_xsct.tcl" line 33)

+ bash /home/nico/projects/P4-NetFPGA/contrib-projects/sume-sdnet-switch/tools/pci_rescan_run.sh
Check programming FPGA or Reboot machine !
+ rmdir sume_riffa
rmdir: ERROR: Module sume_riffa is not currently loaded
+ modprobe sume_riffa
+ ifconfig nf0 up
nf0: ERROR while getting interface flags: No such device
+ ifconfig nf1 up
nf1: ERROR while getting interface flags: No such device
+ ifconfig nf2 up
nf2: ERROR while getting interface flags: No such device
+ ifconfig nf3 up
nf3: ERROR while getting interface flags: No such device
+ bash config_writes.sh
```

D.2 NetFPGA Flash Success

A successful flashing process also emits a couple of errors, however the message “fpga configuration failed. DONE PIN is not HIGH” and its succeeding lines are missing, as seen below.

After that in all cases a reboot is required; the PCI rescan in no tested case showed the nf devices.

```
nico@nsg-System:~$ cd $NF_DESIGN_DIR/bitfiles/
nico@nsg-System:~/projects/P4-NetFPGA/contrib-projects/sume-sdnet-switch/projects/minip4/simple_sume_switch/bitfiles$ sudo bash -c ". $HOME/master-thesis/netpfga/bashinit
++ which vivado
+ xilinx_tool_path=/opt/Xilinx/Vivado/2018.2/bin/vivado
+ bitimage=minip4.bit
+ configWrites=config_writes.sh
+ '[' -z minip4.bit ']'
```

```

+ '[' -z config_writes.sh ']'
+ '[' /opt/Xilinx/Vivado/2018.2/bin/vivado == " " ']'
+ rmmmod sume_riffa
+ xsct /home/nico/projects/P4-NetFPGA/contrib-projects/sume-sdnet-switch/tools/run_xsct.tcl -tclargs minip4.bit
rlwrap: warning: your $TERM is 'xterm-256color' but rlwrap couldn't find it in the terminfo database. Expect some problems.
RUN loading image file.
minip4.bit
attempting to launch hw_server

***** Xilinx hw_server v2018.2
**** Build date : Jun 14 2018-20:18:37
** Copyright 1986-2018 Xilinx, Inc. All Rights Reserved.

INFO: hw_server application started
INFO: Use Ctrl-C to exit hw_server application

INFO: To connect to this hw_server instance use url: TCP:127.0.0.1:3121

100% 19MB 1.7MB/s 00:11
+ bash /home/nico/projects/P4-NetFPGA/contrib-projects/sume-sdnet-switch/tools/pci_rescan_run.sh
Check programming FPGA or Reboot machine !
+ rmmmod sume_riffa
rmmmod: ERROR: Module sume_riffa is not currently loaded
+ modprobe sume_riffa
+ ifconfig nf0 up
nf0: ERROR while getting interface flags: No such device
+ ifconfig nf1 up
nf1: ERROR while getting interface flags: No such device
+ ifconfig nf2 up
nf2: ERROR while getting interface flags: No such device
+ ifconfig nf3 up
nf3: ERROR while getting interface flags: No such device
+ bash config_writes.sh
nico@nsg-System:~/projects/P4-NetFPGA/contrib-projects/sume-sdnet-switch/projects/minip4/simple_sume_switch/bitfiles$

```

D.3 NetFPGA Kernel module

After a successful flash, loading the kernel module will enable nf devices to appear in the operating system.

```

nico@nsg-System:~$ ip l
1: lo: <LOOPBACK,UP,LOWER_UP> mtu 65536 qdisc noqueue state UNKNOWN mode DEFAULT group default qlen 1000
    link/loopback 00:00:00:00:00:00 brd 00:00:00:00:00:00
2: eth0: <BROADCAST,MULTICAST,UP,LOWER_UP> mtu 1500 qdisc pfifo_fast state UP mode DEFAULT group default qlen 1000
    link/ether 74:d0:2b:98:38:f6 brd ff:ff:ff:ff:ff:ff
3: eth1: <BROADCAST,MULTICAST> mtu 1500 qdisc noop state DOWN mode DEFAULT group default qlen 1000
    link/ether f8:f2:le:41:44:9c brd ff:ff:ff:ff:ff:ff
4: eth2: <BROADCAST,MULTICAST> mtu 1500 qdisc noop state DOWN mode DEFAULT group default qlen 1000
    link/ether f8:f2:le:41:44:9d brd ff:ff:ff:ff:ff:ff
5: wg0: <POINTOPOINT,NOARP,UP,LOWER_UP> mtu 1420 qdisc noqueue state UNKNOWN mode DEFAULT group default qlen 1000
    link/none
nico@nsg-System:~$ ~/master-thesis/bin/build-load-drivers.sh
+ cd /home/nico/projects/P4-NetFPGA/lib/sw/std/driver/sume_riffa_v1_0_0
+ sudo modprobe -r sume_riffa
+ make clean
make -C /lib/modules/4.15.0-55-generic/build M=/home/nico/projects/P4-NetFPGA/lib/sw/std/driver/sume_riffa_v1_0_0 clean
make[1]: Entering directory '/usr/src/linux-headers-4.15.0-55-generic'
    CLEAN /home/nico/projects/P4-NetFPGA/lib/sw/std/driver/sume_riffa_v1_0_0/.tmp_versions
    CLEAN /home/nico/projects/P4-NetFPGA/lib/sw/std/driver/sume_riffa_v1_0_0/Module.symvers
make[1]: Leaving directory '/usr/src/linux-headers-4.15.0-55-generic'
+ make all
make -C /lib/modules/4.15.0-55-generic/build M=/home/nico/projects/P4-NetFPGA/lib/sw/std/driver/sume_riffa_v1_0_0 modules
make[1]: Entering directory '/usr/src/linux-headers-4.15.0-55-generic'
    CC [M] /home/nico/projects/P4-NetFPGA/lib/sw/std/driver/sume_riffa_v1_0_0/sume_riffa.o
Building modules, stage 2.
MODPOST 1 modules
    CC /home/nico/projects/P4-NetFPGA/lib/sw/std/driver/sume_riffa_v1_0_0/sume_riffa.mod.o
    LD [M] /home/nico/projects/P4-NetFPGA/lib/sw/std/driver/sume_riffa_v1_0_0/sume_riffa.ko
make[1]: Leaving directory '/usr/src/linux-headers-4.15.0-55-generic'
+ sudo make install
make -C /lib/modules/4.15.0-55-generic/build M=/home/nico/projects/P4-NetFPGA/lib/sw/std/driver/sume_riffa_v1_0_0 modules
make[1]: Entering directory '/usr/src/linux-headers-4.15.0-55-generic'
    Building modules, stage 2.
MODPOST 1 modules
make[1]: Leaving directory '/usr/src/linux-headers-4.15.0-55-generic'
install -o root -g root -m 0755 -d /lib/modules/4.15.0-55-generic/extra/sume_riffa/
install -o root -g root -m 0755 sume_riffa.ko /lib/modules/4.15.0-55-generic/extra/sume_riffa/
depmod -a 4.15.0-55-generic
+ sudo modprobe sume_riffa
+ grep sume_riffa
+ lsmod
sume_riffa                28672  0
nico@nsg-System:~$
nico@nsg-System:~$ ip l
1: lo: <LOOPBACK,UP,LOWER_UP> mtu 65536 qdisc noqueue state UNKNOWN mode DEFAULT group default qlen 1000
    link/loopback 00:00:00:00:00:00 brd 00:00:00:00:00:00
2: eth0: <BROADCAST,MULTICAST,UP,LOWER_UP> mtu 1500 qdisc pfifo_fast state UP mode DEFAULT group default qlen 1000
    link/ether 74:d0:2b:98:38:f6 brd ff:ff:ff:ff:ff:ff
3: eth1: <BROADCAST,MULTICAST> mtu 1500 qdisc noop state DOWN mode DEFAULT group default qlen 1000
    link/ether f8:f2:le:41:44:9c brd ff:ff:ff:ff:ff:ff
4: eth2: <BROADCAST,MULTICAST> mtu 1500 qdisc noop state DOWN mode DEFAULT group default qlen 1000
    link/ether f8:f2:le:41:44:9d brd ff:ff:ff:ff:ff:ff
5: wg0: <POINTOPOINT,NOARP,UP,LOWER_UP> mtu 1420 qdisc noqueue state UNKNOWN mode DEFAULT group default qlen 1000
    link/none
6: nf0: <BROADCAST,MULTICAST> mtu 1500 qdisc noop state DOWN mode DEFAULT group default qlen 1000
    link/ether 02:53:55:4d:45:00 brd ff:ff:ff:ff:ff:ff
7: nf1: <BROADCAST,MULTICAST> mtu 1500 qdisc noop state DOWN mode DEFAULT group default qlen 1000
    link/ether 02:53:55:4d:45:01 brd ff:ff:ff:ff:ff:ff
8: nf2: <BROADCAST,MULTICAST> mtu 1500 qdisc noop state DOWN mode DEFAULT group default qlen 1000
    link/ether 02:53:55:4d:45:02 brd ff:ff:ff:ff:ff:ff
9: nf3: <BROADCAST,MULTICAST> mtu 1500 qdisc noop state DOWN mode DEFAULT group default qlen 1000
    link/ether 02:53:55:4d:45:03 brd ff:ff:ff:ff:ff:ff
nico@nsg-System:~$

```

D.4 NetFPGA misses packets on nf*

While the nf devices appear in the operating system, packets emitted by the netpfga cannot be sniffed on the nf interfaces directly. Instead one has to sniff packets on a physical network card that is connected to the specific output port.

DRAFT

DRAFT

Appendix E

Benchmark Logs

E.1 iperf

Omitting startup time

E.2 General

MTU setting to 1500, as netpfga doesn't support jumbo frames

iperf3, iperf 3.0.11

50 parallel = 2x 10040 parallel = 10030 parallel = 70

Turning back on checksum offloading (see below)

30 parallel = 70

```
root@ESPRIMO-P956:~# ethtool -K enp2s0f0 tx on
Cannot get device udp-fragmentation-offload settings: Operation not supported
Cannot get device udp-fragmentation-offload settings: Operation not supported
Actual changes:
tx-checksumming: on
    tx-checksum-ip-generic: on
    tx-checksum-sctp: on
tcp-segmentation-offload: on
    tx-tcp-segmentation: on
    tx-tcp6-segmentation: on
root@ESPRIMO-P956:~#
root@ESPRIMO-P956:~# ethtool -K enp2s0f1 tx on
Cannot get device udp-fragmentation-offload settings: Operation not supported
Cannot get device udp-fragmentation-offload settings: Operation not supported
Actual changes:
tx-checksumming: on
    tx-checksum-ip-generic: on
    tx-checksum-sctp: on
tcp-segmentation-offload: on
    tx-tcp-segmentation: on
    tx-tcp6-segmentation: on
root@ESPRIMO-P956:~# ethtool -K enp2s0f1 rx on
Cannot get device udp-fragmentation-offload settings: Operation not supported
Cannot get device udp-fragmentation-offload settings: Operation not supported
root@ESPRIMO-P956:~#
```

Results into

```
root@ESPRIMO-P956:~# ethtool -k enp2s0f0
Features for enp2s0f0:
Cannot get device udp-fragmentation-offload settings: Operation not supported
rx-checksumming: on
tx-checksumming: on
    tx-checksum-ipv4: off [fixed]
    tx-checksum-ip-generic: on
    tx-checksum-ipv6: off [fixed]
    tx-checksum-fcoe-crc: on [fixed]
    tx-checksum-sctp: on
scatter-gather: on
    tx-scatter-gather: on
    tx-scatter-gather-fraglist: off [fixed]
tcp-segmentation-offload: on
    tx-tcp-segmentation: on
    tx-tcp-ecn-segmentation: off [fixed]
    tx-tcp-mangleid-segmentation: off
    tx-tcp6-segmentation: on
udp-fragmentation-offload: off
generic-segmentation-offload: on
generic-receive-offload: on
large-receive-offload: off
rx-vlan-offload: on
tx-vlan-offload: on
ntuple-filters: off
receive-hashing: on
highdma: on [fixed]
rx-vlan-filter: on
vlan-challenged: off [fixed]
```

```

tx-lockless: off [fixed]
netns-local: off [fixed]
tx-gso-robust: off [fixed]
tx-fcoe-segmentation: on [fixed]
tx-gre-segmentation: on
tx-gre-csum-segmentation: on
tx-ixip4-segmentation: on
tx-ixip6-segmentation: on
tx-udp_tnl-segmentation: on
tx-udp_tnl-csum-segmentation: on
tx-gso-partial: on
tx-sctp-segmentation: off [fixed]
tx-esp-segmentation: off [fixed]
fcoe-mtu: off [fixed]
tx-nocache-copy: off
loopback: off [fixed]
rx-fcs: off [fixed]
rx-all: off
tx-vlan-stag-hw-insert: off [fixed]
rx-vlan-stag-hw-parse: off [fixed]
rx-vlan-stag-filter: off [fixed]
12-fwd-offload: off
hw-tc-offload: off
esp-hw-offload: off [fixed]
esp-tx-csum-hw-offload: off [fixed]
rx-udp_tunnel-port-offload: off
root@ESPRIMO-P956:~# ethtool -k enp2s0f1
Features for enp2s0f1:
Cannot get device udp-fragmentation-offload settings: Operation not supported
rx-checksumming: on
tx-checksumming: on
    tx-checksum-ipv4: off [fixed]
    tx-checksum-ip-generic: on
    tx-checksum-ipv6: off [fixed]
    tx-checksum-fcoe-crc: on [fixed]
    tx-checksum-sctp: on
scatter-gather: on
    tx-scatter-gather: on
    tx-scatter-gather-fraglist: off [fixed]
tcp-segmentation-offload: on
    tx-tcp-segmentation: on
    tx-tcp-ecn-segmentation: off [fixed]
    tx-tcp-mangleid-segmentation: off
    tx-tcp6-segmentation: on
udp-fragmentation-offload: off
generic-segmentation-offload: on
generic-receive-offload: on
large-receive-offload: off
rx-vlan-offload: on
tx-vlan-offload: on
ntuple-filters: off
receive-hashing: on
highdma: on [fixed]
rx-vlan-filter: on
vlan-challenged: off [fixed]
tx-lockless: off [fixed]
netns-local: off [fixed]
tx-gso-robust: off [fixed]
tx-fcoe-segmentation: on [fixed]
tx-gre-segmentation: on
tx-gre-csum-segmentation: on
tx-ixip4-segmentation: on
tx-ixip6-segmentation: on
tx-udp_tnl-segmentation: on
tx-udp_tnl-csum-segmentation: on
tx-gso-partial: on
tx-sctp-segmentation: off [fixed]
tx-esp-segmentation: off [fixed]
fcoe-mtu: off [fixed]
tx-nocache-copy: off
loopback: off [fixed]
rx-fcs: off [fixed]
rx-all: off
tx-vlan-stag-hw-insert: off [fixed]
rx-vlan-stag-hw-parse: off [fixed]
rx-vlan-stag-filter: off [fixed]
12-fwd-offload: off
hw-tc-offload: off
esp-hw-offload: off [fixed]
esp-tx-csum-hw-offload: off [fixed]
rx-udp_tunnel-port-offload: off
root@ESPRIMO-P956:~#

```

E.3 NetFPGA

iperf3-tcp-listening-v4 connected by v6

```

nico@ESPRIMO-P956:~$ iperf3 -p 2345 -4 -B 10.0.0.42 -s
-----
Server listening on 2345
-----
Accepted connection from 10.0.0.66, port 50900
[ 5] local 10.0.0.42 port 2345 connected to 10.0.0.66 port 50902
[ ID] Interval      Transfer      Bandwidth
[ 5] 0.00-1.00 sec   693 MBytes   5.81 Gbits/sec
[ 5] 1.00-2.00 sec   645 MBytes   5.41 Gbits/sec
[ 5] 2.00-3.00 sec   644 MBytes   5.40 Gbits/sec
[ 5] 3.00-4.00 sec   868 MBytes   7.28 Gbits/sec
[ 5] 4.00-5.00 sec   853 MBytes   7.16 Gbits/sec
[ 5] 5.00-6.00 sec   913 MBytes   7.66 Gbits/sec
[ 5] 6.00-7.00 sec   774 MBytes   6.49 Gbits/sec
[ 5] 7.00-8.00 sec   641 MBytes   5.38 Gbits/sec
[ 5] 8.00-9.00 sec   911 MBytes   7.64 Gbits/sec
[ 5] 9.00-10.00 sec  733 MBytes   6.15 Gbits/sec
[ 5] 10.00-10.04 sec 25.8 MBytes  5.38 Gbits/sec
-----
[ ID] Interval      Transfer      Bandwidth      Retr          sender
[ 5] 0.00-10.04 sec  7.52 GBytes   6.43 Gbits/sec  14
[ 5] 0.00-10.04 sec  7.52 GBytes   6.43 Gbits/sec
receiver

```



```
-----
Server listening on 2345
-----
nico@ESPRIMO-P956:~$ iperf3 -6 -p 2345 -c 2001:db8:42::a00:2a
Connecting to host 2001:db8:42::a00:2a, port 2345
[ 4] local 2001:db8:42::42 port 50902 connected to 2001:db8:42::a00:2a port 2345
[ ID] Interval      Transfer      Bandwidth    Retr  Cwnd
[ 4] 0.00-1.00    sec  719 MBytes   6.03 Gbits/sec  10  449 KBytes
[ 4] 1.00-2.00    sec  645 MBytes   5.41 Gbits/sec   0  449 KBytes
[ 4] 2.00-3.00    sec  644 MBytes   5.40 Gbits/sec   0  449 KBytes
[ 4] 3.00-4.00    sec  878 MBytes   7.36 Gbits/sec   0  449 KBytes
[ 4] 4.00-5.00    sec  859 MBytes   7.20 Gbits/sec   0  449 KBytes
[ 4] 5.00-6.00    sec  910 MBytes   7.64 Gbits/sec   0  449 KBytes
[ 4] 6.00-7.00    sec  758 MBytes   6.36 Gbits/sec   0  449 KBytes
[ 4] 7.00-8.00    sec  658 MBytes   5.52 Gbits/sec   0  449 KBytes
[ 4] 8.00-9.00    sec  906 MBytes   7.60 Gbits/sec   4  449 KBytes
[ 4] 9.00-10.00   sec  724 MBytes   6.07 Gbits/sec   0  449 KBytes
-----
[ ID] Interval      Transfer      Bandwidth    Retr
[ 4] 0.00-10.00   sec  7.52 GBytes   6.46 Gbits/sec  14
[ 4] 0.00-10.00   sec  7.52 GBytes   6.46 Gbits/sec
-----
iperf Done.
nico@ESPRIMO-P956:~$
```

listening on v6, connecting from v4:

```
nico@ESPRIMO-P956:~$ iperf3 -p 2345 -6 -B 2001:db8:42::42 -s
-----
Server listening on 2345
-----
Accepted connection from 2001:db8:42::a00:2a, port 47520
[ 5] local 2001:db8:42::42 port 2345 connected to 2001:db8:42::a00:2a port 47522
[ ID] Interval      Transfer      Bandwidth    Retr  Cwnd
[ 5] 0.00-1.00    sec  1.02 GBytes   8.73 Gbits/sec  53  208 KBytes
[ 5] 1.00-2.00    sec  879 MBytes   7.38 Gbits/sec   6  379 KBytes
[ 5] 2.00-3.00    sec  859 MBytes   7.20 Gbits/sec   0  423 KBytes
[ 5] 3.00-4.00    sec  1.02 GBytes   8.78 Gbits/sec  37  364 KBytes
[ 5] 4.00-5.00    sec  1.04 GBytes   8.89 Gbits/sec   1  450 KBytes
[ 5] 5.00-6.00    sec  1.05 GBytes   9.00 Gbits/sec   0  462 KBytes
[ 5] 6.00-7.00    sec  1.03 GBytes   8.89 Gbits/sec  30  324 KBytes
[ 5] 7.00-8.00    sec  1.04 GBytes   8.91 Gbits/sec   0  471 KBytes
[ 5] 8.00-9.00    sec  1.03 GBytes   8.84 Gbits/sec  10  452 KBytes
[ 5] 9.00-10.00   sec  953 MBytes   7.99 Gbits/sec  14  409 KBytes
[ 5] 10.00-10.04 sec  38.6 MBytes  7.81 Gbits/sec
-----
[ ID] Interval      Transfer      Bandwidth    Retr
[ 5] 0.00-10.04   sec  9.89 GBytes   8.46 Gbits/sec  151
[ 5] 0.00-10.04   sec  9.89 GBytes   8.46 Gbits/sec
-----
Server listening on 2345
-----
nico@ESPRIMO-P956:~$ iperf3 -4 -p 2345 -c 10.0.0.66
Connecting to host 10.0.0.66, port 2345
[ 4] local 10.0.0.42 port 47522 connected to 10.0.0.66 port 2345
[ ID] Interval      Transfer      Bandwidth    Retr  Cwnd
[ 4] 0.00-1.00    sec  1.06 GBytes   9.10 Gbits/sec  53  208 KBytes
[ 4] 1.00-2.00    sec  867 MBytes   7.27 Gbits/sec   6  379 KBytes
[ 4] 2.00-3.00    sec  870 MBytes   7.29 Gbits/sec   0  423 KBytes
[ 4] 3.00-4.00    sec  1.02 GBytes   8.77 Gbits/sec  37  364 KBytes
[ 4] 4.00-5.00    sec  1.04 GBytes   8.91 Gbits/sec   1  450 KBytes
[ 4] 5.00-6.00    sec  1.05 GBytes   8.98 Gbits/sec   0  462 KBytes
[ 4] 6.00-7.00    sec  1.04 GBytes   8.92 Gbits/sec  30  324 KBytes
[ 4] 7.00-8.00    sec  1.04 GBytes   8.88 Gbits/sec   0  471 KBytes
[ 4] 8.00-9.00    sec  1.03 GBytes   8.86 Gbits/sec  10  452 KBytes
[ 4] 9.00-10.00   sec  947 MBytes   7.94 Gbits/sec  14  409 KBytes
-----
[ ID] Interval      Transfer      Bandwidth    Retr
[ 4] 0.00-10.00   sec  9.89 GBytes   8.49 Gbits/sec  151
[ 4] 0.00-10.00   sec  9.89 GBytes   8.49 Gbits/sec
-----
iperf Done.
nico@ESPRIMO-P956:~$
```

E.4 Tayga

```
ii tayga                                0.9.2-6                                amd64                                userspace stateless NAT64
```

Setting up IPv4 networking

```
[15:12] nsg-System:~# ip addr add 10.0.0.77/24 dev eth1
[15:12] nsg-System:~# ip l s eth1 up

nico@ESPRIMO-P956:~$ ~/master-thesis/bin/init_ipv4_esprimo.sh
nico@ESPRIMO-P956:~$ cat ~/master-thesis/bin/init_ipv4_esprimo.sh
#!/bin/sh

sudo ip addr add 10.0.0.42/24 dev enp2s0f0
sudo ip link set enp2s0f0 up

nico@ESPRIMO-P956:~$ sudo ip route add 10.0.1.0/24 via 10.0.0.77
```

Verify networking works:

```
[15:12] nsg-System:~# ping 10.0.0.42
PING 10.0.0.42 (10.0.0.42) 56(84) bytes of data.
64 bytes from 10.0.0.42: icmp_seq=1 ttl=64 time=0.304 ms
64 bytes from 10.0.0.42: icmp_seq=2 ttl=64 time=0.097 ms
^C
-- 10.0.0.42 ping statistics --
```

```
2 packets transmitted, 2 received, 0% packet loss, time 1011ms
rtt min/avg/max/mdev = 0.097/0.200/0.304/0.104 ms
[15:12] nsg-System:~#
```

Setting up IPv6 networking

```
nico@ESPRIMO-P956:~$ ip addr show dev enp2s0f1
13: enp2s0f1: <BROADCAST,MULTICAST,UP,LOWER_UP> mtu 1500 qdisc mq state UP group default qlen 1000
    link/ether f8:f2:1e:09:62:d1 brd ff:ff:ff:ff:ff:ff
    inet6 2001:db8:42::42/64 scope global
        valid_lft forever preferred_lft forever
    inet6 fe80::faf2:1eff:fe09:62d1/64 scope link
        valid_lft forever preferred_lft forever
nico@ESPRIMO-P956:~$ sudo ip route add 2001:db8:23::/96 via 2001:db8:42::77

[15:12] nsg-System:~# ip addr add 2001:db8:42::77/64 dev eth2
[15:15] nsg-System:~# ip link set eth2 up
```

Verify IPv6 networking works:

```
nico@ESPRIMO-P956:~$ ping6 -c2 2001:db8:42::77
PING 2001:db8:42::77(2001:db8:42::77) 56 data bytes
64 bytes from 2001:db8:42::77: icmp_seq=1 ttl=64 time=0.169 ms
64 bytes from 2001:db8:42::77: icmp_seq=2 ttl=64 time=0.153 ms

-- 2001:db8:42::77 ping statistics --
2 packets transmitted, 2 received, 0% packet loss, time 1010ms
rtt min/avg/max/mdev = 0.153/0.161/0.169/0.008 ms
nico@ESPRIMO-P956:~$
```

Enabling IPv6 and IPv4 forwarding:

```
[15:16] nsg-System:~# sysctl -w net.ipv6.conf.all.forwarding=1
net.ipv6.conf.all.forwarding = 1

[15:20] nsg-System:~# sysctl -w net.ipv4.ip_forward=1
net.ipv4.ip_forward = 1
```

Testing NAT64 in tayga

```
nico@ESPRIMO-P956:~$ ping -c2 10.0.1.42
PING 10.0.1.42 (10.0.1.42) 56(84) bytes of data.
64 bytes from 10.0.1.42: icmp_seq=1 ttl=61 time=0.356 ms
64 bytes from 10.0.1.42: icmp_seq=2 ttl=61 time=0.410 ms

-- 10.0.1.42 ping statistics --
2 packets transmitted, 2 received, 0% packet loss, time 1019ms
rtt min/avg/max/mdev = 0.356/0.383/0.410/0.027 ms
nico@ESPRIMO-P956:~$

nico@ESPRIMO-P956:~$ sudo tcpdump -ni enp2s0f1
tcpdump: verbose output suppressed, use -v or -vv for full protocol decode
listening on enp2s0f1, link-type EN10MB (Ethernet), capture size 262144 bytes
15:21:39.851057 IP6 2001:db8:23::a00:2a > 2001:db8:42::42: ICMP6, echo request, seq 1, length 64
15:21:39.851124 IP6 2001:db8:42::42 > 2001:db8:23::a00:2a: ICMP6, echo reply, seq 1, length 64
15:21:40.870448 IP6 2001:db8:23::a00:2a > 2001:db8:42::42: ICMP6, echo request, seq 2, length 64
15:21:40.870507 IP6 2001:db8:42::42 > 2001:db8:23::a00:2a: ICMP6, echo reply, seq 2, length 64
^C
4 packets captured
4 packets received by filter
0 packets dropped by kernel
nico@ESPRIMO-P956:~$
```

Testing NAT64 (v6 to v4)

```
nico@ESPRIMO-P956:~$ ping6 -c2 2001:db8:23::a00:2a
PING 2001:db8:23::a00:2a(2001:db8:23::a00:2a) 56 data bytes
64 bytes from 2001:db8:23::a00:2a: icmp_seq=1 ttl=61 time=0.240 ms
64 bytes from 2001:db8:23::a00:2a: icmp_seq=2 ttl=61 time=0.400 ms

-- 2001:db8:23::a00:2a ping statistics --
2 packets transmitted, 2 received, 0% packet loss, time 1003ms
rtt min/avg/max/mdev = 0.240/0.320/0.400/0.080 ms
nico@ESPRIMO-P956:~$
```

E.4.1 Tayga/TCP

Tayga running at 100

v4->v6 tcp delivering 3.36 gbit/s at P1 3.30 Gbit/s at P20 3.11 gbit/s at P50

v6->v4 tcp P1: 3.02 Gbit/s P20: 3.28 gbit/s P50: 2.85 gbit/s

Commands:

```
Server always: iperf3 -6 -p 2345 -B 2001:db8:42::42 -s | tee iperf-tayga-v4tov6server-P50

nico@ESPRIMO-P956:~/master-thesis/iperf$ iperf3 -4 -p 2345 -t 70 -O 10 -P1 -c 10.0.1.42 -T taygav4tov6tcpP1 | tee iperf-tayga-v4tov6server-client
nico@ESPRIMO-P956:~/master-thesis/iperf$ iperf3 -4 -p 2345 -t 70 -O 10 -P20 -c 10.0.1.42 -T taygav4tov6tcpP20 | tee iperf-tayga-v4tov6server-client-P20
nico@ESPRIMO-P956:~/master-thesis/iperf$ iperf3 -4 -p 2345 -t 70 -O 10 -P50 -c 10.0.1.42 -T taygav4tov6tcpP50 | tee iperf-tayga-v4tov6server-client-P50

nico@ESPRIMO-P956:~/master-thesis/iperf$ iperf3 -4 -p 2345 -B 10.0.0.42 -s | tee iperf-tayga-v6tov4-server-P1
```

Testing v6->v4

```
nico@ESPRIMO-P956:~/master-thesis/iperf$ iperf3 -4 -p 2345 -B 10.0.0.42 -s | tee iperf-tayga-v6tov4-server-P20
nico@ESPRIMO-P956:~/master-thesis/iperf$ iperf3 -6 -p 2345 -t 70 -O 10 -P1 -c 2001:db8:23::a00:2a -T taygav6tov4tcpP1 | tee iperf-tayga-v6tov4-client-P1
nico@ESPRIMO-P956:~/master-thesis/iperf$ iperf3 -6 -p 2345 -t 70 -O 10 -P20 -c 2001:db8:23::a00:2a -T taygav6tov4tcpP20 | tee iperf-tayga-v6tov4-client-P20
nico@ESPRIMO-P956:~/master-thesis/iperf$ iperf3 -6 -p 2345 -t 70 -O 10 -P50 -c 2001:db8:23::a00:2a -T taygav6tov4tcpP50 | tee iperf-tayga-v6tov4-client-P50
```

UDP v6->v4, again 100

P1: 5.81 gbit/s P20: 9.40 gbit/s P50: 19.6 gbits/sec

On the line only ca. 3600 mbit/s seen

```
nico@ESPRIMO-P956:~/master-thesis/iperf$ iperf3 -4 -p 2345 -B 10.0.0.42 -s | tee iperf-tayga-v6tov4-server-udp-P1
nico@ESPRIMO-P956:~/master-thesis/iperf$ iperf3 -6 -p 2345 -t 70 -O 10 -P1 -u -b10000m -c 2001:db8:23::a00:2a -T taygav6tov4tcpP50 | tee iperf-tayga-v6tov4-client-udp-P1
nico@ESPRIMO-P956:~/master-thesis/iperf$ iperf3 -6 -p 2345 -t 70 -O 10 -P50 -u -b10000m -c 2001:db8:23::a00:2a -T taygav6tov4tcpP50 | tee iperf-tayga-v6tov4-client-udp-P50
```

Messages from server:

```
nico@ESPRIMO-P956:~/master-thesis/iperf$ iperf3 -4 -p 2345 -B 10.0.0.42 -s | tee iperf-tayga-v6tov4-server-udp-P1
iperf3: OUT OF ORDER - incoming packet = 198902 and received packet = 198904 AND SP = 5
iperf3: OUT OF ORDER - incoming packet = 441615 and received packet = 441617 AND SP = 5
iperf3: OUT OF ORDER - incoming packet = 441616 and received packet = 441618 AND SP = 5
iperf3: OUT OF ORDER - incoming packet = 567495 and received packet = 567501 AND SP = 5
iperf3: OUT OF ORDER - incoming packet = 567496 and received packet = 567501 AND SP = 5
iperf3: OUT OF ORDER - incoming packet = 567497 and received packet = 567501 AND SP = 5
iperf3: OUT OF ORDER - incoming packet = 567499 and received packet = 567503 AND SP = 5
iperf3: OUT OF ORDER - incoming packet = 567500 and received packet = 567503 AND SP = 5
iperf3: OUT OF ORDER - incoming packet = 567502 and received packet = 567503 AND SP = 5
iperf3: OUT OF ORDER - incoming packet = 631160 and received packet = 631164 AND SP = 5
iperf3: OUT OF ORDER - incoming packet = 631161 and received packet = 631164 AND SP = 5
iperf3: OUT OF ORDER - incoming packet = 631162 and received packet = 631165 AND SP = 5
iperf3: OUT OF ORDER - incoming packet = 631163 and received packet = 631165 AND SP = 5
```

UDP v4->v6, again 100

P1: 8.26 gbit/s [atop: 2500 Mbit/s per direction] P20: 9.92 Gbits/sec [atop: 2500 Mbit/s per direction] P50: 19.3 gbit/s [atop: 2500 Mbit/s per direction]

```
nico@ESPRIMO-P956:~/master-thesis/iperf$ iperf3 -6 -p 2345 -B 2001:db8:42::42 -s | tee iperf-tayga-v4tov6-server-udp-P1
nico@ESPRIMO-P956:~/master-thesis/iperf$ iperf3 -4 -p 2345 -t 70 -O 10 -P1 -u -b0 -c 10.0.1.42 -T taygav4tov6udpP1 | tee iperf-tayga-v4tov6server-client-udp-P1
nico@ESPRIMO-P956:~/master-thesis/iperf$ iperf3 -4 -p 2345 -t 70 -O 10 -P20 -u -b0 -c 10.0.1.42 -T taygav4tov6udpP20 | tee iperf-tayga-v4tov6server-client-udp-P20
nico@ESPRIMO-P956:~/master-thesis/iperf$ iperf3 -4 -p 2345 -t 70 -O 10 -P50 -u -b0 -c 10.0.1.42 -T taygav4tov6udpP50 | tee iperf-tayga-v4tov6server-client-udp-P50
```

E.5 Jool

E.5.1 Jool Setup

Installation of 4.0.1 from <https://www.jool.mx/en/download.html>.

```
nico@nsg-System:~$ wget https://github.com/NICMx/Jool/releases/download/v4.0.1/jool_4.0.1.tar.gz
nico@nsg-System:~$ tar xvfz jool_4.0.1.tar.gz
nico@nsg-System:~$ cd jool-4.0.1/
nico@nsg-System:~/jool-4.0.1$ sudo apt install linux-headers-$(uname -r)
nico@nsg-System:~/jool-4.0.1$ sudo apt install libnl-genl-3-dev
```

xtables cannot be found:

```
nico@nsg-System:~/jool-4.0.1$ sudo apt install libxtables-dev
Reading package lists... Done
Building dependency tree
Reading state information... Done
E: Unable to locate package libxtables-dev
nico@nsg-System:~/jool-4.0.1$
```

Does not compile without:

```
checking for library containing argp_parse... none required
checking for pkg-config... /usr/bin/pkg-config
checking pkg-config is at least version 0.9.0... yes
checking for LIBNLGENL3... yes
checking for XTABLES... no
configure: error: Package requirements (xtables) were not met:

No package 'xtables' found

Consider adjusting the PKG_CONFIG_PATH environment variable if you
installed software in a non-standard prefix.

Alternatively, you may set the environment variables XTABLES_CFLAGS
and XTABLES_LIBS to avoid the need to call pkg-config.
See the pkg-config man page for more details.
nico@nsg-System:~/jool-4.0.1$
```

Trying different package:

```
nico@nsg-System:~/jool-4.0.1$ sudo apt install iptables-dev
```

Compiles!

```
nico@nsg-System:~/jool-4.0.1$ sudo make install
```

E.5.2 Jool Configuration

Loading module:

```
nico@nsg-System:~/jool-4.0.1$ sudo modprobe jool_siit
```

enabling forwarding:

```
sysctl -w net.ipv4.conf.all.forwarding=1
sysctl -w net.ipv6.conf.all.forwarding=1
```

Mapping configuration:

```
nico@nsg-System:~/jool-4.0.1$ sudo jool_siit instance add example -iptables -pool6 2001:db8:23::/96
nico@nsg-System:~/jool-4.0.1$ sudo ip6tables -t mangle -A PREROUTING \
-s 2001:db8:42::/64 -d 2001:db8:23::/96 -j JOOL_SIIT -instance example
nico@nsg-System:~/jool-4.0.1$ sudo iptables -t mangle -A PREROUTING \
-s 10.0.0.0/24 -j JOOL_SIIT -instance example
```

Debugging:

```
[16:39] nsg-System:~# lsmod|grep jool
jool_siit          147456  2
x_tables          40960  5 jool_siit,ip6_tables,ip_tables,ip6table_mangle,ip6table_mangle
[16:39] nsg-System:~#
[16:41] nsg-System:~# jool_siit -i example stats display -explain
JSTAT64_DST: 276
Translations cancelled: IPv6 packet's destination address did not match pool6 nor any EAMT entries, or the resulting address was blacklisted.
```

Try 2 w/ eamt:

```
[16:53] nsg-System:~# modprobe jool_siit
[16:54] nsg-System:~# jool_siit instance add "example" -iptables
[16:54] nsg-System:~# jool_siit -i example eamt add 2001:db8:42::/120 10.0.1.0/24
[16:55] nsg-System:~# jool_siit -i example eamt add 2001:db8:23::/120 10.0.0.0/24
[16:57] nsg-System:~# ip6tables -t mangle -A PREROUTING -s 2001:db8:42::/120 -d 2001:db8:23::/120 -j JOOL_SIIT -instance example
[16:57] nsg-System:~# iptables -t mangle -A PREROUTING -s 10.0.0.0/24 -d 10.0.1.0/24 -j JOOL_SIIT -instance example
[16:57] nsg-System:~#
```

Testing NAT64:

```
nico@ESPRIMO-P956:~/master-thesis/iperf$ ping6 2001:db8:23::2a
PING 2001:db8:23::2a(2001:db8:23::2a) 56 data bytes
64 bytes from 2001:db8:23::2a: icmp_seq=1 ttl=63 time=0.199 ms
64 bytes from 2001:db8:23::2a: icmp_seq=2 ttl=63 time=0.282 ms
64 bytes from 2001:db8:23::2a: icmp_seq=3 ttl=63 time=0.186 ms
^C
-- 2001:db8:23::2a ping statistics --
3 packets transmitted, 3 received, 0% packet loss, time 2040ms
rtt min/avg/max/mdev = 0.186/0.222/0.282/0.044 ms
nico@ESPRIMO-P956:~/master-thesis/iperf$ ping 10.0.1.66
PING 10.0.1.66 (10.0.1.66) 56(84) bytes of data.
64 bytes from 10.0.1.66: icmp_seq=1 ttl=63 time=0.218 ms
64 bytes from 10.0.1.66: icmp_seq=2 ttl=63 time=0.281 ms
64 bytes from 10.0.1.66: icmp_seq=3 ttl=63 time=0.280 ms
^C
-- 10.0.1.66 ping statistics --
3 packets transmitted, 3 received, 0% packet loss, time 2051ms
rtt min/avg/max/mdev = 0.218/0.259/0.281/0.034 ms
nico@ESPRIMO-P956:~/master-thesis/iperf$
```

E.5.3 Jool Benchmarks

v4->v6 tcp

P1: 8.24 gbit/s no cpu load visible P20: 8.26 gbit/s iperf 42 + 10P50: 8.29 gbit/s

v6->v4 tcp

P1: 8.22 P20: 8.22 15/60P50: 8.23 iperf: 73/16

Commands:

```
nico@ESPRIMO-P956:~/master-thesis/iperf$ iperf3 -6 -p 2345 -B 2001:db8:42::42 -s | tee iperf-jool-v4tov6-server-tcp-P50
nico@ESPRIMO-P956:~/master-thesis/iperf$ iperf3 -4 -p 2345 -t 70 -O 10 -P1 -c 10.0.1.66 | tee iperf-jool-v4tov6-client-tcp-P1
nico@ESPRIMO-P956:~/master-thesis/iperf$ iperf3 -4 -p 2345 -t 70 -O 10 -P20 -c 10.0.1.66 | tee iperf-jool-v4tov6-client-tcp-P20
nico@ESPRIMO-P956:~/master-thesis/iperf$ iperf3 -4 -p 2345 -t 70 -O 10 -P50 -c 10.0.1.66 | tee iperf-jool-v4tov6-client-tcp-P50

Other way:

nico@ESPRIMO-P956:~/master-thesis/iperf$ iperf3 -4 -p 2345 -B 10.0.0.42 -s | tee iperf-jool-v6tov4-server-tcp-P1
nico@ESPRIMO-P956:~/master-thesis/iperf$ iperf3 -6 -p 2345 -t 70 -O 10 -P1 -c 2001:db8:23::2a | tee iperf-jool-v6tov4-client-tcp-P1
...
nico@ESPRIMO-P956:~/master-thesis/iperf$ iperf3 -6 -p 2345 -t 70 -O 10 -P1 -b0 -u -c 2001:db8:23::2a | tee iperf-jool-v6tov4-client-tcp-P1
```

v4->v6 udp

P1: 4.46 iperf 30P20: 18.8 iperf 100P50: 22.8 iperf 100

```
nico@ESPRIMO-P956:~/master-thesis/iperf$ iperf3 -6 -p 2345 -B 2001:db8:42::42 -s | tee iperf-jool-v4tov6-server-udp-P1
nico@ESPRIMO-P956:~/master-thesis/iperf$ iperf3 -4 -p 2345 -t 70 -O 10 -P1 -c 10.0.1.66 -u -b0 | tee iperf-jool-v4tov6-client-udp-P1
nico@ESPRIMO-P956:~/master-thesis/iperf$ iperf3 -4 -p 2345 -t 70 -O 10 -P20 -c 10.0.1.66 -u -b0 | tee iperf-jool-v4tov6-client-udp-P20
```

v6->v4 udp

P1: 6.67 gbit/s iperf 50/50P20: 16.8 nat64: iperf: ? 100P50: 20.5 Gbits/sec nat64: 100

Turning off offloading, redoing tcp:

```
root@ESPRIMO-P956:~# ethtool -K enp2s0f0 gso off
Cannot get device udp-fragmentation-offload settings: Operation not supported
Cannot get device udp-fragmentation-offload settings: Operation not supported
root@ESPRIMO-P956:~# ethtool -K enp2s0f0 rx off
Cannot get device udp-fragmentation-offload settings: Operation not supported
Cannot get device udp-fragmentation-offload settings: Operation not supported
root@ESPRIMO-P956:~# ethtool -K enp2s0f0 tx off
Cannot get device udp-fragmentation-offload settings: Operation not supported
Cannot get device udp-fragmentation-offload settings: Operation not supported
Actual changes:
tx-checksumming: off
tx-checksum-ip-generic: off
tx-checksum-sctp: off
tcp-segmentation-offload: off
tx-tcp-segmentation: off [requested on]
tx-tcp6-segmentation: off [requested on]
root@ESPRIMO-P956:~# ethtool -K enp2s0f1 tx off
Cannot get device udp-fragmentation-offload settings: Operation not supported
Cannot get device udp-fragmentation-offload settings: Operation not supported
Actual changes:
tx-checksumming: off
tx-checksum-ip-generic: off
tx-checksum-sctp: off
tcp-segmentation-offload: off
tx-tcp-segmentation: off [requested on]
tx-tcp6-segmentation: off [requested on]
root@ESPRIMO-P956:~# ethtool -K enp2s0f1 rx off
Cannot get device udp-fragmentation-offload settings: Operation not supported
Cannot get device udp-fragmentation-offload settings: Operation not supported
root@ESPRIMO-P956:~# ethtool -K enp2s0f1 gso off
Cannot get device udp-fragmentation-offload settings: Operation not supported
Cannot get device udp-fragmentation-offload settings: Operation not supported
root@ESPRIMO-P956:~#

[17:26] nsg-System:~# ethtool -K eth1 tx off
Cannot get device udp-fragmentation-offload settings: Operation not supported
Cannot get device udp-fragmentation-offload settings: Operation not supported
Actual changes:
tx-checksumming: off
tx-checksum-ip-generic: off
tx-checksum-sctp: off
tcp-segmentation-offload: off
tx-tcp-segmentation: off [requested on]
tx-tcp6-segmentation: off [requested on]
[17:26] nsg-System:~# ethtool -K eth1 gso off
Cannot get device udp-fragmentation-offload settings: Operation not supported
Cannot get device udp-fragmentation-offload settings: Operation not supported
[17:26] nsg-System:~# ethtool -K eth2 gso off
Cannot get device udp-fragmentation-offload settings: Operation not supported
Cannot get device udp-fragmentation-offload settings: Operation not supported
[17:26] nsg-System:~# ethtool -K eth2 rx off
Cannot get device udp-fragmentation-offload settings: Operation not supported
Cannot get device udp-fragmentation-offload settings: Operation not supported
[17:26] nsg-System:~# ethtool -K eth2 tx off
Cannot get device udp-fragmentation-offload settings: Operation not supported
Cannot get device udp-fragmentation-offload settings: Operation not supported
Actual changes:
tx-checksumming: off
tx-checksum-ip-generic: off
tx-checksum-sctp: off
tcp-segmentation-offload: off
tx-tcp-segmentation: off [requested on]
tx-tcp6-segmentation: off [requested on]
[17:26] nsg-System:~#
```

Retesting using -P50:

Still no cpu load with tcp, 100

result: 7.96 gbit/s

```
nico@ESPRIMO-P956:~/master-thesis/iperf$ iperf3 -4 -p 2345 -B 10.0.0.42 -s | tee iperf-jool-v6tov4-server-tcp-P50-no-offload
nico@ESPRIMO-P956:~/master-thesis/iperf$ iperf3 -6 -p 2345 -t 70 -O 10 -P50 -c 2001:db8:23::2a | tee iperf-jool-v6tov4-client-tcp-P50-no-offload
nico@ESPRIMO-P956:~/master-thesis/iperf$ iperf3 -4 -p 2345 -t 70 -O 10 -P20 -u -b0 -c 10.0.0.66 | tee iperf-netpfga-v4tov6-client-udp-P20

nico@ESPRIMO-P956:~/master-thesis/iperf$ iperf3 -4 -p 2345 -B 10.0.0.42 -s | tee iperf-netpfga-v6tov4-server-tcp-P1
nico@ESPRIMO-P956:~/master-thesis/iperf$ iperf3 -6 -p 2345 -t 70 -O 10 -P1 -c 2001:db8:42::a00:2a | tee iperf-netpfga-v6tov4-client-tcp-P1

nico@ESPRIMO-P956:~/master-thesis/iperf$ iperf3 -4 -p 2345 -B 10.0.0.42 -s | tee iperf-netpfga-v6tov4-server-udp-P1
nico@ESPRIMO-P956:~/master-thesis/iperf$ iperf3 -6 -p 2345 -t 70 -O 10 -P1 -b0 -u -c 2001:db8:42::a00:2a | tee iperf-netpfga-v6tov4-client-udp-P1
```

E.5.4 NetPFGA Benchmarks

Only 1 test did have offloading on esprimo off, was redone

v4->v6 tcp

P1: 7.41 gbit/s iperf 50P1-offload-on-esprimo: 8.43 gbit/s P20: 9.29 gbit/s iperf: 66/20P50: 9.29 gbit/s 84/42

v4->v6 udp

P1: 7.4gbit/s 100P20: 17.7gbit/s iperf 100P50: 21.5 gbit/s iperf 100

v6->v4 tcp

P1: 9.28 gbit/s atop 9800 mbit/s iperf 44P20: 9.29 gbit/s atop 9800 mbit/s iperf 70P50: 9.29 gbit/s atop 9800 mbit/s iperf 90

v6->v4 udp

P1: 7.96 gbit/s atop 8200mbit/s iperf 70P20: 13.4 gbit/s atop 9800 mbit/s iperf 100P50: 19.0 gbit/s atop 9800 mbit/s iperf 100

Commands:

```
nico@ESPRIMO-P956:~/master-thesis/iperf$ iperf3 -4 -p 2345 -t 70 -O 10 -P1 -u -b0 -c 10.0.0.66 | tee iperf-netpfga-v4tov6-client-udp-P1
```

After first netpfga, tcp v4->v6 p1 turned offloading on again

```
root@ESPRIMO-P956:~# ethtool -K enp2s0f1 tx-checksum-ipv6 on
Cannot get device udp-fragmentation-offload settings: Operation not supported
Cannot get device udp-fragmentation-offload settings: Operation not supported
Could not change any device features
root@ESPRIMO-P956:~# ethtool -K enp2s0f1 tx on
Cannot get device udp-fragmentation-offload settings: Operation not supported
Cannot get device udp-fragmentation-offload settings: Operation not supported
Actual changes:
tx-checksumming: on
  tx-checksum-ip-generic: on
  tx-checksum-sctp: on
tcp-segmentation-offload: on
  tx-tcp-segmentation: on
  tx-tcp6-segmentation: on
root@ESPRIMO-P956:~# ethtool -K enp2s0f1 rx on
Cannot get device udp-fragmentation-offload settings: Operation not supported
Cannot get device udp-fragmentation-offload settings: Operation not supported
root@ESPRIMO-P956:~# ethtool -K enp2s0f1 gso on
Cannot get device udp-fragmentation-offload settings: Operation not supported
Cannot get device udp-fragmentation-offload settings: Operation not supported
root@ESPRIMO-P956:~# ethtool -K enp2s0f0 gso on
Cannot get device udp-fragmentation-offload settings: Operation not supported
Cannot get device udp-fragmentation-offload settings: Operation not supported
root@ESPRIMO-P956:~# ethtool -K enp2s0f0 tx on
Cannot get device udp-fragmentation-offload settings: Operation not supported
Cannot get device udp-fragmentation-offload settings: Operation not supported
Actual changes:
tx-checksumming: on
  tx-checksum-ip-generic: on
  tx-checksum-sctp: on
tcp-segmentation-offload: on
  tx-tcp-segmentation: on
  tx-tcp6-segmentation: on
root@ESPRIMO-P956:~# ethtool -K enp2s0f0 rx on
Cannot get device udp-fragmentation-offload settings: Operation not supported
Cannot get device udp-fragmentation-offload settings: Operation not supported
root@ESPRIMO-P956:~#
```

Appendix F

Buffer

F.1 NetFPGA compile errors

- infinite loop in installer

```
# Fix introduced for SDNet 2017.4
sed -i 's/xsim.dir/xsc\dpil\so\g' nf_summe_sdnet_ip/SimpleSumeSwitch/vivado_sim.bash
sed -i 's/xsim.dir/xsc\dpil\so\g' nf_summe_sdnet_ip/SimpleSumeSwitch/vivado_sim_waveform.bash
# Fix introduced for SDNet 2018.2
sed -i 's/glbl_sim/glbl/g' nf_summe_sdnet_ip/SimpleSumeSwitch/vivado_sim_waveform.bash
sed -i 's/SimpleSumeSwitch_tb_sim#work.glbl/SimpleSumeSwitch_tb/g' nf_summe_sdnet_ip/SimpleSumeSwitch/vivado_sim_waveform.bash
cp src/*.tbl nf_summe_sdnet_ip/SimpleSumeSwitch/
cp: cannot stat 'src/*.tbl': No such file or directory
make: *** [Makefile:23: cpp_test] Error 1
[23:12] loch:minip4%

ERROR: [XSIM 43-3409] Failed to compile generated C file xsim.dir/work.SimpleSumeSwitch_tb#work.glbl/obj/xsim_3.c.
ERROR: [XSIM 43-3915] Encountered a fatal error. Cannot continue. Exiting...

/opt/Xilinx/Vivado/2018.2/data/./tps/llvm/3.1/lnx64.o/bin/clang -fPIC -c -std-gnu89 -nobuiltininc -nostdinc++ -w -Wl,-unres
olved-symbols-ignore-in-object-files -fbracket-depth=1048576 -I/opt/Xilinx/Vivado/2018.2/data/./tps/llvm/3.1/lnx64.o/bin/./ll
b/clang/3.1/include -fPIC -m64 -I"/opt/Xilinx/Vivado/2018.2/data/xsim/include" "xsim.dir/work.SimpleSumeSwitch_tb#work.glbl/ob
j/xsim_3.c" -O0 -sim -o "xsim.dir/work.SimpleSumeSwitch_tb#work.glbl/obj/xsim_3.lnx64.o" -DXILINX_SIMULATOR
/opt/Xilinx/Vivado/2018.2/data/./tps/llvm/3.1/lnx64.o/bin/clang: error while loading shared libraries: libncurses.so.5: cannot
open shared object file: No such file or directory
ERROR: [XSIM 43-3409] Failed to compile generated C file xsim.dir/work.SimpleSumeSwitch_tb#work.glbl/obj/xsim_3.c.
ERROR: [XSIM 43-3915] Encountered a fatal error. Cannot continue. Exiting...
[20:00] rainbow:SimpleSumeSwitch%

# Fix introduced for SDNet 2018.2
sed -i 's/glbl_sim/glbl/g' nf_summe_sdnet_ip/SimpleSumeSwitch/vivado_sim_waveform.bash
sed -i 's/SimpleSumeSwitch_tb_sim#work.glbl/SimpleSumeSwitch_tb/g' nf_summe_sdnet_ip/SimpleSumeSwitch/vivado_sim_waveform.bash
cp src/*.tbl nf_summe_sdnet_ip/SimpleSumeSwitch/
cp testdata/*.txt nf_summe_sdnet_ip/SimpleSumeSwitch/
cp: cannot stat 'testdata/*.txt': No such file or directory
make: *** [Makefile:17: all] Error 1
[15:46] rainbow:minip4%

make -C testdata/
make[1]: Entering directory '/home/nico/projects/P4-NetFPGA/contrib-projects/sume-sdnet-switch/projects/minip4/testdata'
./gen_testdata.py
/home/nico/projects/P4-NetFPGA/contrib-projects/sume-sdnet-switch/bin/pcap2axi -output Packet_in.axi -bus_width 256 src.pcap
Traceback (most recent call last):
  File "/home/nico/projects/P4-NetFPGA/contrib-projects/sume-sdnet-switch/bin/pcap2axi", line 108, in <module>
    write_to_file(args.file_pcap, args.output)
  File "/home/nico/projects/P4-NetFPGA/contrib-projects/sume-sdnet-switch/bin/pcap2axi", line 88, in write_to_file
    for pkt in rdpcap(file_in):
  File "/usr/lib/python2.7/dist-packages/scapy/utils.py", line 728, in rdpcap
    with PcapReader(filename) as fdesc:
  File "/usr/lib/python2.7/dist-packages/scapy/utils.py", line 751, in __call__
    filename, fdesc, magic = cls.open(filename)
  File "/usr/lib/python2.7/dist-packages/scapy/utils.py", line 778, in open
    fdesc = open(filename, "rb")
IOError: [Errno 2] No such file or directory: 'src.pcap'
make[1]: *** [Makefile:5: all] Error 1
make[1]: Leaving directory '/home/nico/projects/P4-NetFPGA/contrib-projects/sume-sdnet-switch/projects/minip4/testdata'
make: *** [Makefile:32: frontend] Error 2
[15:47] rainbow:minip4%

update_compile_order: Time (s): cpu = 00:00:17 ; elapsed = 00:00:09 . Memory (MB): peak = 1995.594 ; gain = 0.016 ; free physic
al = 21975 ; free virtual = 33161
loading libsume..
Traceback (most recent call last):
  File "/home/nico/projects/P4-NetFPGA/contrib-projects/sume-sdnet-switch/projects/minip4/simple_summe_switch/test/sim_switch_de
fault/run.py", line 42, in <module>
    import config_writes
  File "/home/nico/projects/P4-NetFPGA/contrib-projects/sume-sdnet-switch/projects/minip4/simple_summe_switch/test/sim_switch_de
fault/config_writes.py", line 7
    ^
IndentationError: expected an indented block
    while executing
    "exec python $::env(NF_DESIGN_DIR)/test/${test_name}/run.py"
    invoked from within
    "set output [exec python $::env(NF_DESIGN_DIR)/test/${test_name}/run.py]"
    (file "/home/nico/projects/P4-NetFPGA/contrib-projects/sume-sdnet-switch/projects/minip4/simple_summe_switch/hw/tcl/simple_s
ume_switch_sim.tcl" line 177)
INFO: [Common 17-206] Exiting Vivado at Sat May 18 15:21:21 2019...
```



```

[14:54] rainbow:bitfiles% cd $NF_DESIGN_DIR/bitfiles/ && sudo bash ./program_switch.sh
./program_switch.sh: line 34: /tools/program_switch.sh: No such file or directory
[14:56] rainbow:bitfiles% ls
config_writes.sh  minip4.bit  program_switch.sh  README
[14:56] rainbow:bitfiles%

root@rainbow:~/master-thesis/netpfga/minip4/sw/hw_test_tool# python switch_calc_tester.py
SIOCSIFADDR: No such device
eth1: ERROR while getting interface flags: No such device
SIOCSIFNETMASK: No such device
tcpdump: eth1: No such device exists
(SIOCSIFHWADDR: No such device)
The HW testing tool for the switch_calc design
type help to see all commands
testing>

» table_cam_add_entry lookup_table send_to_port1 ff:ff:ff:ff:ff:ff =>
CAM_Init_ValidateContext() - done
WROTE 0x44020050 = 0xffffffff
WROTE 0x44020054 = 0xfffff
WROTE 0x44020080 = 0x0003
python: ioctl: Unknown error 512
[20:27] rainbow:CLI%

[7:05] rainbow:netpfga% bash build-load-drivers.sh
+ cd /home/nico/projects/P4-NetFPGA/lib/sw/std/driver/sume_riffa_v1_0_0
+ make all
make -C /lib/modules/5.0.0-16-generic/build M=/home/nico/projects/P4-NetFPGA/lib/sw/std/driver/sume_riffa_v1_0_0 modules
make[1]: Entering directory '/usr/src/linux-headers-5.0.0-16-generic'
Building modules, stage 2.
MODPOST 1 modules
make[1]: Leaving directory '/usr/src/linux-headers-5.0.0-16-generic'
+ sudo make install
make -C /lib/modules/5.0.0-16-generic/build M=/home/nico/projects/P4-NetFPGA/lib/sw/std/driver/sume_riffa_v1_0_0 modules
make[1]: Entering directory '/usr/src/linux-headers-5.0.0-16-generic'
Building modules, stage 2.
MODPOST 1 modules
make[1]: Leaving directory '/usr/src/linux-headers-5.0.0-16-generic'
install -o root -g root -m 0755 -d /lib/modules/5.0.0-16-generic/extra/sume_riffa/
install -o root -g root -m 0755 sume_riffa.ko /lib/modules/5.0.0-16-generic/extra/sume_riffa/
depmod -a 5.0.0-16-generic
+ sudo modprobe sume_riffa
modprobe: ERROR: could not insert 'sume_riffa': Exec format error
[7:06] rainbow:netpfga%

java traceback when trying to install sdnets
#BEGIN_CENTER
Exception in thread "AWT-EventQueue-0" java.lang.IllegalArgumentException: Window must not be zero
at java.desktop/sun.awt.X11.XAtom.checkWindow(Unknown Source)
at java.desktop/sun.awt.X11.XAtom.getAtomData(Unknown Source)
at java.desktop/sun.awt.X11.XToolkit.getWorkArea(Unknown Source)
at java.desktop/sun.awt.X11.XToolkit.getInsets(Unknown Source)
at java.desktop/sun.awt.X11.XToolkit.getScreenInsets(Unknown Source)
at java.desktop/java.awt.Window.init(Unknown Source)
at java.desktop/java.awt.Window.<init>(Unknown Source)
at java.desktop/java.awt.Window.<init>(Unknown Source)
at java.desktop/java.awt.Dialog.<init>(Unknown Source)
at java.desktop/java.awt.Dialog.<init>(Unknown Source)
at java.desktop/javafx.swing.JDialog.<init>(Unknown Source)
at java.desktop/javafx.swing.JOptionPane.createDialog(Unknown Source)
at java.desktop/javafx.swing.JOptionPane.createDialog(Unknown Source)
at j.a.c(Unknown Source)
at j.a.a(Unknown Source)
at j.a.a(Unknown Source)
at j.a.c(Unknown Source)
at com.xilinx.installer.gui.panel.destination.b.a(Unknown Source)
at com.xilinx.installer.gui.panel.destination.DestinationPanel.z(Unknown Source)
at com.xilinx.installer.gui.E.a(Unknown Source)
at com.xilinx.installer.gui.InstallerGUI.l(Unknown Source)
at com.xilinx.installer.gui.i.actionPerformed(Unknown Source)
at java.desktop/javafx.swing.AbstractButton.fireActionPerformed(Unknown Source)
at java.desktop/javafx.swing.AbstractButton$Handler.actionPerformed(Unknown Source)
at java.desktop/javafx.swing.DefaultButtonModel.fireActionPerformed(Unknown Source)
at java.desktop/javafx.swing.DefaultButtonModel.setPressed(Unknown Source)
at java.desktop/javafx.swing.plaf.basic.BasicButtonListener.mouseReleased(Unknown Source)
at java.desktop/java.awt.Component.processMouseEvent(Unknown Source)
at java.desktop/javafx.swing.JComponent.processMouseEvent(Unknown Source)
at java.desktop/java.awt.Component.processEvent(Unknown Source)
at java.desktop/java.awt.Container.processEvent(Unknown Source)
at java.desktop/java.awt.Component.dispatchEventImpl(Unknown Source)
at java.desktop/java.awt.Container.dispatchEventImpl(Unknown Source)
at java.desktop/java.awt.Component.dispatchEvent(Unknown Source)
at java.desktop/java.awt.LightweightDispatcher.retargetMouseEvent(Unknown Source)
at java.desktop/java.awt.LightweightDispatcher.processMouseEvent(Unknown Source)
at java.desktop/java.awt.LightweightDispatcher.dispatchEvent(Unknown Source)
at java.desktop/java.awt.Container.dispatchEventImpl(Unknown Source)
at java.desktop/java.awt.Window.dispatchEventImpl(Unknown Source)
at java.desktop/java.awt.Component.dispatchEvent(Unknown Source)
at java.desktop/java.awt.EventQueue.dispatchEventImpl(Unknown Source)
at java.desktop/java.awt.EventQueue.access$500(Unknown Source)
at java.desktop/java.awt.EventQueue$3.run(Unknown Source)
at java.desktop/java.awt.EventQueue$3.run(Unknown Source)
at java.base/java.security.AccessController.doPrivileged(Native Method)
at java.base/java.security.ProtectionDomain$JavaSecurityAccessImpl.doIntersectionPrivilege(Unknown Source)
at java.base/java.security.ProtectionDomain$JavaSecurityAccessImpl.doIntersectionPrivilege(Unknown Source)
at java.desktop/java.awt.EventQueue$4.run(Unknown Source)
at java.desktop/java.awt.EventQueue$4.run(Unknown Source)
at java.base/java.security.AccessController.doPrivileged(Native Method)
at java.base/java.security.ProtectionDomain$JavaSecurityAccessImpl.doIntersectionPrivilege(Unknown Source)
at java.desktop/java.awt.EventQueue.dispatchEvent(Unknown Source)
at java.desktop/java.awt.EventDispatchThread.pumpOneEventForFilters(Unknown Source)
at java.desktop/java.awt.EventDispatchThread.pumpEventsForFilter(Unknown Source)
at java.desktop/java.awt.EventDispatchThread.pumpEventsForHierarchy(Unknown Source)
at java.desktop/java.awt.EventDispatchThread.pumpEvents(Unknown Source)
at java.desktop/java.awt.EventDispatchThread.pumpEvents(Unknown Source)
at java.desktop/java.awt.EventDispatchThread.run(Unknown Source)
#END_CENTER

Reason was a hidden window.

```

Testing the card

```
-----
[ddr3B]: Running Auto Test
-----
Traceback (most recent call last):
  File "/usr/lib/python2.7/dist-packages/wx-3.0-gtk2/wx/_core.py", line 16765, in <lambda>
    lambda event: event.callable(*event.args, **event.kw) )
  File "sw/host/script/NfSumeTest.py", line 848, in UpdateProgress
    self.progressDlg.Update(self.curProgress, str(localLine))
  File "/usr/lib/python2.7/dist-packages/wx-3.0-gtk2/wx/_core.py", line 16710, in __getattr__
    raise PyDeadObjectError(self.attrStr % self._name)
wx._core.PyDeadObjectError: The C++ part of the NfSumeProgress object has been deleted, attribute access no longer allowed.
Exception in thread Thread-18:
Traceback (most recent call last):
  File "/usr/lib/python2.7/threading.py", line 801, in __bootstrap_inner
    self.run()
  File "sw/host/script/NfSumeTest.py", line 947, in run
    self.target(*self.data)
  File "sw/host/script/NfSumeTest.py", line 355, in StartAutoTest
    self.TestInterface(testName)
  File "sw/host/script/NfSumeTest.py", line 465, in TestInterface
    self.ProgramFpga('./../bitfiles/' + self.nfSumeTestConfiguration[testName]['bitstream'])
  File "sw/host/script/NfSumeTest.py", line 586, in ProgramFpga
    self.getFpgaIndex()
  File "sw/host/script/NfSumeTest.py", line 574, in getFpgaIndex
    p = Popen(['djtgcfg', 'init', '-d', 'NetSUME'], stdout=PIPE, bufsize = 1)
  File "/usr/lib/python2.7/subprocess.py", line 711, in __init__
    errread, errwrite)
  File "/usr/lib/python2.7/subprocess.py", line 1343, in _execute_child
    raise child_exception
OSError: [Errno 2] No such file or directory

-----
[pcie]: Running Auto Test
-----
Traceback (most recent call last):
  File "/usr/lib/python2.7/dist-packages/wx-3.0-gtk2/wx/_core.py", line 16765, in <lambda>
    lambda event: event.callable(*event.args, **event.kw) )
  File "sw/host/script/NfSumeTest.py", line 848, in UpdateProgress
    self.progressDlg.Update(self.curProgress, str(localLine))
  File "/usr/lib/python2.7/dist-packages/wx-3.0-gtk2/wx/_core.py", line 16710, in __getattr__
    raise PyDeadObjectError(self.attrStr % self._name)
wx._core.PyDeadObjectError: The C++ part of the NfSumeProgress object has been deleted, attribute access no longer allowed.
Exception in thread Thread-21:
Traceback (most recent call last):
  File "/usr/lib/python2.7/threading.py", line 801, in __bootstrap_inner
    self.run()
  File "sw/host/script/NfSumeTest.py", line 947, in run
    self.target(*self.data)
  File "sw/host/script/NfSumeTest.py", line 466, in TestInterface
    self.serialCon.readlines()
  File "/usr/lib/python2.7/dist-packages/serial/serialposix.py", line 495, in read
    raise SerialException('device reports readiness to read but returned no data (device disconnected or multiple access on port?)')
SerialException: device reports readiness to read but returned no data (device disconnected or multiple access on port?)

```

Another generated file problem:

```
nico@nsg-System:~/master-thesis/netpfga$ grep -i error $P4_PROJECT_DIR/nf_sume_sdnet_ip/SimpleSumeSwitch/LOG
ERROR: [VRFC 10-1491] unexpected EOF [/home/nico/master-thesis/netpfga/minip4/nf_sume_sdnet_ip/SimpleSumeSwitch/S_CONTROLLERs.HDL/S_CONTROLLER_SimpleSumeSwitch.vp:37]
INFO: [VRFC 10-311] analyzing module TopDeparser_t_EngineStage_0_ErrorCheck
INFO: [VRFC 10-311] analyzing module TopDeparser_t_EngineStage_1_ErrorCheck
INFO: [VRFC 10-311] analyzing module TopDeparser_t_EngineStage_2_ErrorCheck
INFO: [VRFC 10-311] analyzing module TopDeparser_t_EngineStage_3_ErrorCheck
INFO: [VRFC 10-311] analyzing module TopDeparser_t_EngineStage_4_ErrorCheck
INFO: [VRFC 10-311] analyzing module TopDeparser_t_EngineStage_5_ErrorCheck
INFO: [VRFC 10-311] analyzing module TopDeparser_t_EngineStage_6_ErrorCheck

```

function syntax not supported

```
make[1]: Entering directory '/home/nico/projects/P4-NetFPGA/contrib-projects/sume-sdnet-switch/projects/minip4/src'
p4c-sdnet -o minip4.sdnet -sdnet_info .sdnet_switch_info.dat minip4_solution.p4
headers.p4(246):syntax error, unexpected IDENTIFIER, expecting (
bit<16> ones_complement_sum
*****
error: 1 errors encountered, aborting compilation
Makefile:34: recipe for target 'all' failed
make[1]: *** [all] Error 1
make[1]: Leaving directory '/home/nico/projects/P4-NetFPGA/contrib-projects/sume-sdnet-switch/projects/minip4/src'
Makefile:31: recipe for target 'frontend' failed
make: *** [frontend] Error 2
nico@nsg-System:~/master-thesis/netpfga$

nico@nsg-System:~/projects/P4-NetFPGA/contrib-projects/sume-sdnet-switch/projects/minip4/simple_sume_switch/test/sim_switch_default$ cd $NF_DESIGN_DIR/test/sim_switch
rm -f config_writes.py*
rm -f *.pyc
cp /home/nico/projects/P4-NetFPGA/contrib-projects/sume-sdnet-switch/projects/minip4/testdata/config_writes.py ./
cp: cannot stat '/home/nico/projects/P4-NetFPGA/contrib-projects/sume-sdnet-switch/projects/minip4/testdata/config_writes.py': No such file or directory
Makefile:36: recipe for target 'all' failed
make: *** [all] Error 1

Finished scanning sources
INFO: [IP_Flow 19-234] Refreshing IP repositories
INFO: [IP_Flow 19-1700] Loaded user IP repository '/home/nico/projects/P4-NetFPGA/contrib-projects/sume-sdnet-switch/projects/minip4/simple_sume_switch/hw/ip_repo'.
INFO: [IP_Flow 19-2313] Loaded Vivado IP repository '/opt/Xilinx/Vivado/2018.2/data/ip'.
WARNING: [IP_Flow 19-3664] IP 'bd_7ad4_xpcs_0' generated file not found '/home/nico/projects/P4-NetFPGA/contrib-projects/sume-sdnet-switch/projects/minip4/simple_sume'.
WARNING: [IP_Flow 19-3664] IP 'bd_alaa_xpcs_0' generated file not found '/home/nico/projects/P4-NetFPGA/contrib-projects/sume-sdnet-switch/projects/minip4/simple_sume'.
open_project: Time (s): cpu = 00:00:05 ; elapsed = 00:00:05 . Memory (MB): peak = 1365.715 ; gain = 188.977 ; free physical = 9396 ; free virtual = 15104
# puts "\nOpening $design Implementation design\n"

```

```
WARNING: [Synth 8-689] width (12) of port connection 'control_S_AXI_ARADDR' does not match port width (8) of module 'SimpleSumeSwitch' [/home/nico/projects/P4-NetFPGA/cont
ERROR: [Synth 8-448] named port connection 'tuple_out_sume_metadata_VALID' does not exist for instance 'SimpleSumeSwitch_inst' of module 'SimpleSumeSwitch' [/home/nico/proj
ERROR: [Synth 8-448] named port connection 'tuple_out_sume_metadata_DATA' does not exist for instance 'SimpleSumeSwitch_inst' of module 'SimpleSumeSwitch' [/home/nico/proj
ERROR: [Synth 8-6156] failed synthesizing module 'nf_sume_sdnets' [/home/nico/projects/P4-NetFPGA/contrib-projects/sume-sdnets-switch/projects/minip4/simple_sume_switch/hw/p
ERROR: [Synth 8-6156] failed synthesizing module 'nf_sume_sdnets_ip' [/home/nico/projects/P4-NetFPGA/contrib-projects/sume-sdnets-switch/projects/minip4/simple_sume_switch/hw/p
ERROR: [Synth 8-6156] failed synthesizing module 'nf_datapath' [/home/nico/projects/P4-NetFPGA/contrib-projects/sume-sdnets-switch/projects/minip4/simple_sume_switch/hw/hdl
ERROR: [Synth 8-6156] failed synthesizing module 'top' [/home/nico/projects/P4-NetFPGA/contrib-projects/sume-sdnets-switch/projects/minip4/simple_sume_switch/hw/hdl/top.v:4
```

Missing “source” files:

```
cc -c -fPIC /home/nico/projects/P4-NetFPGA/contrib-projects/sume-sdnets-switch/projects/minip4/sw/API/CAM.c -I/home/nico/projects/P4-NetFPGA/contrib-projects/sume-sdnets-switch
cc -std=c99 -Wall -Werror -fPIC -c libcam.c -I/home/nico/projects/P4-NetFPGA/contrib-projects/sume-sdnets-switch/sw/sume -I/home/nico/projects/P4-NetFPGA/contrib-projects/sw
cc -L/home/nico/projects/P4-NetFPGA/contrib-projects/sume-sdnets-switch/sw/sume -shared -o libcam.so libcam.o CAM.o -lsumereg
/usr/bin/ld: cannot find -lsumereg
collect2: error: ld returned 1 exit status
Makefile:52: recipe for target 'libcam' failed
make[1]: *** [libcam] Error 1
make[1]: Leaving directory '/home/nico/master-thesis/netpfga/minip4/sw/CLI'
ERROR: could not compile libcam source files
```

Generated files not found:

```
make: Leaving directory '/home/nico/projects/P4-NetFPGA/contrib-projects/sume-sdnets-switch/projects/minip4/simple_sume_switch/test'
cp: cannot stat '/home/nico/projects/P4-NetFPGA/contrib-projects/sume-sdnets-switch/projects/minip4/simple_sume_switch/hw/Makefile': No such file or directory
cp: cannot stat '/home/nico/projects/P4-NetFPGA/contrib-projects/sume-sdnets-switch/projects/minip4/simple_sume_switch/test/nf_interface_0_log.axi': No such file or directory
cp: cannot stat '/home/nico/projects/P4-NetFPGA/contrib-projects/sume-sdnets-switch/projects/minip4/simple_sume_switch/test/nf_interface_0_expected.axi': No such file or directory
cp: cannot stat '/home/nico/projects/P4-NetFPGA/contrib-projects/sume-sdnets-switch/projects/minip4/simple_sume_switch/test/nf_interface_0_stim.axi': No such file or directory
cp: cannot stat '/home/nico/projects/P4-NetFPGA/contrib-projects/sume-sdnets-switch/projects/minip4/simple_sume_switch/test/nf_interface_1_log.axi': No such file or directory
cp: cannot stat '/home/nico/projects/P4-NetFPGA/contrib-projects/sume-sdnets-switch/projects/minip4/simple_sume_switch/test/nf_interface_1_stim.axi': No such file or directory
cp: cannot stat '/home/nico/projects/P4-NetFPGA/contrib-projects/sume-sdnets-switch/projects/minip4/simple_sume_switch/test/nf_interface_1_expected.axi': No such file or directory
cp: cannot stat '/home/nico/projects/P4-NetFPGA/contrib-projects/sume-sdnets-switch/projects/minip4/simple_sume_switch/test/nf_interface_2_log.axi': No such file or directory
cp: cannot stat '/home/nico/projects/P4-NetFPGA/contrib-projects/sume-sdnets-switch/projects/minip4/simple_sume_switch/test/nf_interface_2_stim.axi': No such file or directory
cp: cannot stat '/home/nico/projects/P4-NetFPGA/contrib-projects/sume-sdnets-switch/projects/minip4/simple_sume_switch/test/nf_interface_2_expected.axi': No such file or directory
cp: cannot stat '/home/nico/projects/P4-NetFPGA/contrib-projects/sume-sdnets-switch/projects/minip4/simple_sume_switch/test/nf_interface_3_log.axi': No such file or directory
cp: cannot stat '/home/nico/projects/P4-NetFPGA/contrib-projects/sume-sdnets-switch/projects/minip4/simple_sume_switch/test/nf_interface_3_stim.axi': No such file or directory
cp: cannot stat '/home/nico/projects/P4-NetFPGA/contrib-projects/sume-sdnets-switch/projects/minip4/simple_sume_switch/test/nf_interface_3_expected.axi': No such file or directory
cp: cannot stat '/home/nico/projects/P4-NetFPGA/contrib-projects/sume-sdnets-switch/projects/minip4/simple_sume_switch/test/dma_0_log.axi': No such file or directory
cp: cannot stat '/home/nico/projects/P4-NetFPGA/contrib-projects/sume-sdnets-switch/projects/minip4/simple_sume_switch/test/dma_0_expected.axi': No such file or directory
cp: cannot stat '/home/nico/projects/P4-NetFPGA/contrib-projects/sume-sdnets-switch/projects/minip4/simple_sume_switch/test/reg_stim.log': No such file or directory
cp: cannot stat '/home/nico/projects/P4-NetFPGA/contrib-projects/sume-sdnets-switch/projects/minip4/simple_sume_switch/test/reg_expect.axi': No such file or directory
cp: cannot stat '/home/nico/projects/P4-NetFPGA/contrib-projects/sume-sdnets-switch/projects/minip4/simple_sume_switch/test/reg_stim.axi': No such file or directory
NetFPGA environment:
  Root dir: /home/nico/projects/P4-NetFPGA
  Project name: simple_sume_switch
  Project dir: /tmp/nico/test/simple_sume_switch
  Work dir: /tmp/nico
512
=== Work directory is /tmp/nico/test/simple_sume_switch
=== Setting up test in /tmp/nico/test/simple_sume_switch/sim_switch_default
=== Running test /tmp/nico/test/simple_sume_switch/sim_switch_default ... using cmd ['/home/nico/projects/P4-NetFPGA/contrib-projects/sume-sdnets-switch/projects/minip4/sw/CLI']
+ date
Die Jul 23 13:34:54 CEST 2019
+ [ = no ]
+ cd /home/nico/projects/P4-NetFPGA/contrib-projects/sume-sdnets-switch/projects/minip4/simple_sume_switch
+ make
make: *** No targets specified and no makefile found. Stop.
```

Renaming variables breaks the compile process

```
@Xilinx_MaxPacketRegion(1024)
control_TopDeparser(
- packet_out b,
- in Parsed_packet p,
+ packet_out packet,
+ in Parsed_packet_hdr,
  in user_metadata_t user_metadata,
  inout digest_data_t digest_data,
  inout sume_metadata_t sume_metadata) {
  apply {
-   b.emit(p.etherenet);
+   packet.emit(hdr.etherenet);
  }
+
+
}
```

LPM size must be != 64

```
minip4_solution.p4(38): [-Wwarn=uninitialized_out_param] warning: out parameter meta may be uninitialized when RealParser terminates
  out metadata meta,
  ^^^^^
minip4_solution.p4(35)
parser RealParser(
  ^^^^^^^^^^^^^
error: LPM table size should be 2^n - 1
actions_nat64_generic.p4(169): error: could not not map table size size
  size = 64;
  ^^^^^
error: table match_types are not the same
actions_arp.p4(35): error: could not map table key(s) KeyElement
  hdr.arp.dst_ipv4_addr: lpm;
  ^^^^^^^^^^^^^^^^^^^^^
error: LPM table size should be 2^n - 1
actions_arp.p4(55): error: could not not map table size size
  size = 64;
  ^^^^^
Makefile:34: recipe for target 'all' failed
make[1]: *** [all] Error 1
make[1]: Leaving directory '/home/nico/projects/P4-NetFPGA/contrib-projects/sume-sdnets-switch/projects/minip4/src'
Makefile:31: recipe for target 'frontend' failed
make: *** [frontend] Error 2
nico@nsg-System:~/master-thesis/netpfga/log$
```

LIMIT table match types are not the same error

```

make[1]: Entering directory '/home/nico/projects/P4-NetFPGA/contrib-projects/sume-sdnet-switch/projects/minip4/src'
p4c-sdnet -o minip4.sdnet -sdnet_info .sdnet_switch_info.dat minip4_solution.p4
actions_egress.p4(52): warning: Table v6_networks is not used; removing
table v6_networks {
    ^^^^^^^^^^^^^
actions_egress.p4(69): warning: Table v4_networks is not used; removing
table v4_networks {
    ^^^^^^^^^^^^^
actions_nat64_generic.p4(174): warning: Table nat46 is not used; removing
table nat46 {
    ^^^^^^
minip4_solution.p4(38): [-Wwarn=uninitialized_out_param] warning: out parameter meta may be uninitialized when RealParser terminates
out metadata meta,
    ^^^^^
minip4_solution.p4(35)
parser RealParser(
    ^^^^^^^^^^^^^
error: table match_types are not the same
actions_arp.p4(35): error: could not map table key(s) KeyElement
    hdr.arp.dst_ipv4_addr: lpm;
    ^^^^^^^^^^^^^^^^^^^^^
Makefile:34: recipe for target 'all' failed
make[1]: *** [all] Error 1

table v4_arp {
    key = {
        hdr.ethernet.dst_addr: exact;
        hdr.arp.opcode: exact;
        hdr.arp.dst_ipv4_addr: lpm;
    }
    actions = {
        controller_debug_table_id;
        arp_reply;
        NoAction;
    }
    size = ICMP6_TABLE_SIZE;
    default_action = controller_debug_table_id(TABLE_ARP);
}

```

Implicit error saying that LPM tables don't work:

```

s/sume-sdnet-switch/projects/minip4/nf_sume_sdnet_ip/SimpleSumeSwitch/realmain_lookup_table_0_t.HDL/xpm_memory.v
[SW] LPM_Init() - start
[SW] LPM_Init() - done
[SW] LPM_LoadDataset() - start
[SW] LPM_LoadDataset() failed with error code = 12
FATAL_ERROR: Vivado Simulator kernel has encountered an exception from DPI C function: LPM_VerifyDataset(). Please correct.
Time: 2016466 ps Iteration: 0 Process: /SimpleSumeSwitch_tb/LPM_VerifyDataset
File: /home/nico/projects/P4-NetFPGA/contrib-projects/sume-sdnet-switch/projects/minip4/nf_sume_sdnet_ip/SimpleSumeSwitch/Testbench/SimpleSumeSwitch_tb.v

minip4_solution.p4(35)
parser RealParser(
    ^^^^^^^^^^^^^
actions_nat64_generic.p4(173): error: table size too small for match_type(EM): 63 < 64
    size = 63;
    ^^
actions_nat64_generic.p4(173): error: could not not map table size size
    size = 63;
    ^^^^^

```

Unsupported default parameters

```

actions_egress.p4(89): error: data-plane arguments in default_actions are currently unsupported: realmain_controller_debug_table_id_0
default_action = controller_debug_table_id(TABLE_V4_NETWORKS);
    ^^^^^^^^^^^^^^^^^^^^^^^^^^^^^^^^^^^^^^^^^^^^^^^^^^^^^^^^^
terminate called after throwing an instance of 'Util::CompilerBug'
what(): In file: /wrk/hdscratch/staff/mohan/p4c_sdnet/build/p4c/extensions/sdnet/translate/core/lookupEngine.cpp:137
Compiler Bug: actions_egress.p4(89): unhandled expression realmain_controller_debug_table_id/realmain_controller_debug_table_id_0(5);
default_action = controller_debug_table_id(TABLE_V4_NETWORKS);
    ^^^^^^^^^^^^^^^^^^^^^^^^^^^^^^^^^^^^^^^^^^^^^^^^^^^^^^^^^

```

Compiler Bug / ifstatement

```

minip4_solution.p4(39)
parser RealParser(
    ^^^^^^^^^^^^^
terminate called after throwing an instance of 'Util::CompilerBug'
what(): In file: /wrk/hdscratch/staff/mohan/p4c_sdnet/build/p4c/extensions/sdnet/writers/pxWriter.h:20
Compiler Bug: unhandled node: <IfStatement>(471564)

Makefile:34: recipe for target 'all' failed
make[1]: *** [all] Error 134
make[1]: Leaving directory '/home/nico/projects/P4-NetFPGA/contrib-projects/sume-sdnet-switch/projects/minip4/src'
Makefile:31: recipe for target 'frontend' failed

```

Applying table "twice" in different branches is impossible (another compiler bug)

```

make -C src/
make[1]: Entering directory '/home/nico/projects/P4-NetFPGA/contrib-projects/sume-sdnet-switch/projects/minip4/src'
p4c-sdnet -o minip4.sdnet -sdnet_info .sdnet_switch_info.dat minip4_solution.p4
minip4_solution.p4(19): [-Wwarn=uninitialized_out_param] warning: out parameter meta may be uninitialized when RealParser terminates
out metadata meta,
    ^^^^^
minip4_solution.p4(16)
parser RealParser(
    ^^^^^^^^^^^^^
terminate called after throwing an instance of 'Util::CompilerBug'
what(): In file: /wrk/hdscratch/staff/mohan/p4c_sdnet/build/p4c/extensions/sdnet/translate/core/tupleEngine.cpp:324
Compiler Bug: overwrite

Makefile:34: recipe for target 'all' failed

```

Adding entries requires setting all parameters

```
» table_cam_add_entry realmain_v6_networks_0 realmain.set_egress_port 42540766411362381960998550477184434178 => 1
ERROR: not enough fields provided to complete _hexify()
```

Broken code that cannot convert long to int:

```
» table_cam_delete_entry realmain_v6_networks_0 42540766411362381960998550477184434179
ERROR: failed to convert 42540766411362381960998550477184434179 of type <type 'long'> to an integer
nico@nsng-System:~/master-thesis/netpfga/minip4/sw/CLI$
```

F.2 P4 error messages

```
Warning: you requested the nanomsg event logger, but bmv2 was compiled without -DBMELOG, and the event logger cannot be activated
Calling target program-options parser
[14:01:44.334] [bmv2] [D] [thread 23356] Set default default entry for table 'MyIngress.icmp6': MyIngress.controller_debug_table_id - 2,
[14:01:44.341] [bmv2] [D] [thread 23356] Set default default entry for table 'MyIngress.nat64': MyIngress.controller_debug_table_id - 1,
[14:01:44.344] [bmv2] [D] [thread 23356] Set default default entry for table 'tbl_act': act -
[14:01:44.345] [bmv2] [D] [thread 23356] Set default default entry for table 'tbl_act_0': act_0 -
[14:01:44.345] [bmv2] [D] [thread 23356] Set default default entry for table 'tbl_nat64_icmp6_generic': MyIngress.nat64_icmp6_generic -
[14:01:44.345] [bmv2] [D] [thread 23356] Set default default entry for table 'tbl_act_1': act_1 -
[14:01:44.345] [bmv2] [D] [thread 23356] Set default default entry for table 'tbl_act_2': act_2 -
[14:01:44.345] [bmv2] [D] [thread 23356] Set default default entry for table 'MyIngress.v4_networks': MyIngress.controller_debug_table_id - 5,
[14:01:44.345] [bmv2] [D] [thread 23356] Set default default entry for table 'MyIngress.v6_networks': MyIngress.controller_debug_table_id - 3,
[14:01:44.346] [bmv2] [D] [thread 23356] Set default default entry for table 'tbl_act_3': act_3 -
Invalid entry type 'expression' in field list
bad json:
```

```
{
  "type" : "expression",
  "value" : {
    "type" : "expression",
    "value" : {
      "left" : null,
      "op" : "d2b",
      "right" : {
        "type" : "field",
        "value" : [ "scalars", "metadata.chk_icmp6_na_ns" ]
      }
    }
  }
}
```

```
../p4src/static-mapping.p4(121): error: MyIngress.nat64, Multiple LPM keys in table
table nat64 {
  ^^^^^
```

Compilation Error

```
table nat64 {
  key = {
    hdr.ipv6.src_addr: lpm;
    hdr.ipv6.dst_addr: lpm;
  }
  actions = {
    controller_debug;
    nat64_static;
    NoAction;
  }
  size = NAT64_TABLE_SIZE;
  default_action = controller_debug;
}
```

```
../p4src/static-mapping.p4(60): error: SwitchStatement: switch statements not allowed in actions
switch(hdr.icmp6.type) {
  ^^^^^
```

No if in actions:

```
../p4src/static-mapping.p4(57): error: MethodCallStatement: Conditional execution in actions is not supported on this target
hdr.icmp6.setValid();
^^^^^^^^^^^^^^^^^^^^
```

```
../p4src/static-mapping.p4(70): error: MethodCallStatement: Conditional execution in actions is not supported on this target
hdr.icmp6.setInvalid();
^^^^^^^^^^^^^^^^^^^^
```

```
../p4src/static-mapping.p4(73): error: MethodCallStatement: Conditional execution in actions is not supported on this target
hdr.icmp6_na_ns.setInvalid();
^^^^^^^^^^^^^^^^^^^^
```

```
../p4src/static-mapping.p4(74): error: MethodCallStatement: Conditional execution in actions is not supported on this target
hdr.icmp6_option_link_layer_addr.setInvalid();
^^^^^^^^^^^^^^^^^^^^
```

Compilation Error

```
p4@ubuntu:~/master-thesis/p4app$
```

```
if(hdr.ipv6.next_header == PROTO_ICMP6) {
  nat64_icmp6();
}
```

```
p4c -target bmv2 -arch v1model -std p4-16 "../p4src/checksum_diff.p4" -o "/home/p4/master-thesis/p4src"
```

```
In file: /home/p4/p4-tools/p4c/backends/bmv2/common/expression.cpp:168
```

```
Compiler Bug: ../p4src/actions_delta_checksum.p4(60): ones_complement_sum(hdr.udp.checksum, tmp); unhandled case
```

```
tmp = ones_complement_sum(hdr.udp.checksum, meta.v6sum);
^^^^^^^^^^^^^^^^^^^^
```

Compilation Error``

Using the following code:

```
``/* copied from
```

```
https://p4.org/p4-spec/docs/PSA-v1.1.0.html#appendix-internetchecksum-implementation
```

```
*/
```

```
bit<16> ones_complement_sum(in bit<16> x, in bit<16> y) {
  bit<17> ret = (bit<17>) x + (bit<17>) y;
  if (ret[16:16] == 1) {
```

```

        ret = ret + 1;
    }
    return ret[15:0];
}""
And p4c version:
""p4@ubuntu:~/master-thesis/p4app$ p4c --version
p4c 0.5 (SHA: 5ae30ee)""

```

F.3 Traces

Proof of stuff working, reference for each stage / feature
 Stuff that needs to be cleaned up

F.4 Introduction

F.4.1 The Task

- Milestone 1: Stateless NAT64/NAT46 translations in P4 - Milestone 2: Stateful (dynamic) NAT64/NAT46 translations - Milestone 3: Hardware adaption

This thesis is into 3 milestone P4 environment a lot of potential Programming language in the network Not only faster, but also more convenient.

**** High speed NAT64 with P4 Currently there are two main open source NAT64 solution available: tayga and jool. The former is a single threaded, cpu bound user space solution, the latter a custom Linux kernel module.

This thesis challenges this status quo by developing a P4 based solution supporting all features of jool/tayga and comparing the performance, security and adaptivity of the solutions.

Describe your task.

```

**** Motivation zeigen
**** IPv6, NetPFGA mehr Möglichkeiten
**** P4 erwähnen
**** Task gut zu zeigen, alles erreicht
**** use cases / sample applications

```

List of Abbreviations

ARP	Address resolution protocol
ASIC	Application-specific integrated circuit
FGPA	Field-programmable gate array
LPM	Longest prefix matching
MTU	Maximum transfer unit
NAT	Network Address Translation
NAT64	Network Address Translation from / to IPv6 to / from IPv4
NDP	Neighbor Discovery Protocol
RIR	Regional Internet Registry

DRAFT

DRAFT

Bibliography

- [1] AFRINIC. Afrinic ipv4 exhaustion. <https://afrinic.net/exhaustion>.
- [2] Akamai. Ipv6 adoption visualization. <https://www.akamai.com/us/en/resources/our-thinking/state-of-the-internet-report/state-of-the-internet-ipv6-adoption-visualization.jsp#countries>.
- [3] T. Anderson and A. L. Popper. Explicit Address Mappings for Stateless IP/ICMP Translation. RFC 7757 (Proposed Standard), Feb. 2016.
- [4] APNIC. Apnic's ipv4 pool status. <https://www.apnic.net/community/ipv4-exhaustion/graphical-information/>.
- [5] ARIN. Ipv4 addressing options. <https://www.arin.net/resources/guide/ipv4/>.
- [6] M. Bagnulo, P. Matthews, and I. van Beijnum. Stateful NAT64: Network Address and Protocol Translation from IPv6 Clients to IPv4 Servers. RFC 6146 (Proposed Standard), Apr. 2011.
- [7] C. Bao, C. Huitema, M. Bagnulo, M. Boucadair, and X. Li. IPv6 Addressing of IPv4/IPv6 Translators. RFC 6052 (Proposed Standard), Oct. 2010.
- [8] S. Blake-Wilson, M. Nystrom, D. Hopwood, J. Mikkelsen, and T. Wright. Transport Layer Security (TLS) Extensions. RFC 4366 (Proposed Standard), Apr. 2006. Obsoleted by RFCs 5246, 6066, updated by RFC 5746.
- [9] BMV2. Implementing your switch target with bmv2. <http://www.bmv2.org/>.
- [10] R. Braden, D. Borman, and C. Partridge. Computing the Internet checksum. RFC 1071 (Informational), Sept. 1988. Updated by RFC 1141.
- [11] CISCO. 6lab - the place to monitor ipv6 adoption. <https://6lab.cisco.com/stats/>.
- [12] A. Conta, S. Deering, and M. Gupta (Ed.). Internet Control Message Protocol (ICMPv6) for the Internet Protocol Version 6 (IPv6) Specification. RFC 4443 (Internet Standard), Mar. 2006. Updated by RFC 4884.
- [13] M. Crawford. Transmission of IPv6 Packets over Ethernet Networks. RFC 2464 (Proposed Standard), Dec. 1998. Updated by RFCs 6085, 8064.
- [14] S. Deering, W. Fenner, and B. Haberman. Multicast Listener Discovery (MLD) for IPv6. RFC 2710 (Proposed Standard), Oct. 1999. Updated by RFCs 3590, 3810.
- [15] S. Deering and R. Hinden. Internet Protocol, Version 6 (IPv6) Specification. RFC 2460 (Draft Standard), Dec. 1998. Obsoleted by RFC 8200, updated by RFCs 5095, 5722, 5871, 6437, 6564, 6935, 6946, 7045, 7112.
- [16] R. Fielding, J. Gettys, J. Mogul, H. Frystyk, L. Masinter, P. Leach, and T. Berners-Lee. Hypertext Transfer Protocol – HTTP/1.1. RFC 2616 (Draft Standard), June 1999. Obsoleted by RFCs 7230, 7231, 7232, 7233, 7234, 7235, updated by RFCs 2817, 5785, 6266, 6585.
- [17] L. Foundation. Open vswitch. <https://www.openvswitch.org/>.
- [18] Google. Ipv6 - google. <https://www.google.com/intl/en/ipv6/statistics.html>.

- [19] R. Hinden and S. Deering. IP Version 6 Addressing Architecture. RFC 4291 (Draft Standard), Feb. 2006. Updated by RFCs 5952, 6052, 7136, 7346, 7371, 8064.
- [20] C. Hornig. A Standard for the Transmission of IP Datagrams over Ethernet Networks. RFC 894 (Internet Standard), Apr. 1984.
- [21] E. Juskevicius. Definition of IETF Working Group Document States. RFC 6174 (Informational), Mar. 2011.
- [22] LACNIC. Ipv4 depletion phases. <https://www.lacnic.net/1039/1/lacnic/ipv4-depletion-phases>.
- [23] X. Li, C. Bao, and F. Baker. IP/ICMP Translation Algorithm. RFC 6145 (Proposed Standard), Apr. 2011. Obsoleted by RFC 7915, updated by RFCs 6791, 7757.
- [24] N. Lutchansky. Tayga - simple, no-fuss nat64 for linux. <http://www.litech.org/tayga/>.
- [25] J. McCann, S. Deering, J. Mogul, and R. Hinden (Ed.). Path MTU Discovery for IP version 6. RFC 8201 (Internet Standard), July 2017.
- [26] N. Mexico. Jool an open source siit and nat64 for linux. <https://www.jool.mx/en/index.html>.
- [27] J. Mogul and S. Deering. Path MTU discovery. RFC 1191 (Draft Standard), Nov. 1990.
- [28] T. Narten, E. Nordmark, W. Simpson, and H. Soliman. Neighbor Discovery for IP version 6 (IPv6). RFC 4861 (Draft Standard), Sept. 2007. Updated by RFCs 5942, 6980, 7048, 7527, 7559, 8028, 8319, 8425.
- [29] NetFPGA. P4-netpfga-public repository at github. <https://github.com/NetFPGA/P4-NetFPGA-public>.
- [30] B. Networks. Tofino2. <https://barefootnetworks.com/products/brief-tofino-2/>.
- [31] NGINX. Nginx | high performance load balancer, web server, & reverse proxy. <https://www.nginx.com/>.
- [32] E. Nordmark and R. Gilligan. Basic Transition Mechanisms for IPv6 Hosts and Routers. RFC 4213 (Proposed Standard), Oct. 2005.
- [33] D. Plummer. An Ethernet Address Resolution Protocol: Or Converting Network Protocol Addresses to 48.bit Ethernet Address for Transmission on Ethernet Hardware. RFC 826 (Internet Standard), Nov. 1982. Updated by RFCs 5227, 5494.
- [34] J. Postel. User Datagram Protocol. RFC 768 (Internet Standard), Aug. 1980.
- [35] J. Postel. Internet Control Message Protocol. RFC 792 (Internet Standard), Sept. 1981. Updated by RFCs 950, 4884, 6633, 6918.
- [36] J. Postel. Internet Protocol. RFC 791 (Internet Standard), Sept. 1981. Updated by RFCs 1349, 2474, 6864.
- [37] J. Postel. Transmission Control Protocol. RFC 793 (Internet Standard), Sept. 1981. Updated by RFCs 1122, 3168, 6093, 6528.
- [38] E. Rescorla. The Transport Layer Security (TLS) Protocol Version 1.3. RFC 8446 (Proposed Standard), Aug. 2018.
- [39] RIPE. Ipv4 exhaustion. <https://www.ripe.net/publications/ipv6-info-centre/about-ipv6/ipv4-exhaustion>.
- [40] N. Schottelius. Add access to table keys. <https://github.com/p4lang/p4-spec/issues/745>.

- [41] N. Schottelius. Casting bit<16> to bit<32> in checksum causes incorrect json to be generated. <https://github.com/p4lang/p4c/issues/1765>.
- [42] N. Schottelius. High speed nat64 in p4 (git repository). https://gitlab.ethz.ch/nsg/student-projects/ma-2019-19_high_speed_nat64_with_p4.
- [43] theojeppen. Get size of header. <https://github.com/p4lang/p4-spec/issues/660>.
- [44] ungleich. Die ipv4, die! <https://ungleich.ch/en-us/cms/blog/2019/01/09/die-ipv4-die/>.
- [45] L. Vanbever. Programming network data planes. https://github.com/nsg-ethz/p4-learning/blob/master/slides/02_p4_env.pdf.
- [46] E. Vyncke. Ipv6 deployment aggregated status. <https://www.vyncke.org/ipv6status/>.
- [47] Wikipedia. Ipv4 header checksum. https://en.wikipedia.org/wiki/IPv4_header_checksum. Requested on 2019-08-12.
- [48] Wikipedia. Ipv6 transition mechanism. https://en.wikipedia.org/wiki/IPv6_transition_mechanism. As requested on 2019-08-08.
- [49] Wikipedia. Solicited-node multicast address. https://en.wikipedia.org/wiki/Solicited-node_multicast_address. Requested on 2019-08-13.